

## FITTINGS, ACCESSORIES, LIGHT AND COSMETIC MIRRORS



Art.-Nr.: 03507/020401 Katalog Armaturen und Accessoires, englisch, 11/17

**FOREWORD** 4-5

**FITTINGS AND ACCESSORIES** 6-85

EDITION 400 6-23

EDITION 11 24-35

PLAN 36-59

PLAN S 38-43

PLAN BLUE 46-47

PLAN CARE 56-57

PLAN INTEGRAL 58-59

ELEGANCE 60-71

COLLECTION MOLL 72-83

**FITTINGS** 84-109

IXMO 84-99

UNIVERSAL ARTICLES SHOWER 100-103

meTime\_spa 104-109

**ACCESSORIES** 110-137

EDITION 300 114-115

ASTOR 116-117

CITY.2 118-119

SMART.2 120-127

UNIVERSAL ARTICLES 130-133

SOAP BASKETS 134-137

**LIGHT AND MIRROR** 138-161

COSMETIC MIRRORS 140-145

LIGHT MIRRORS 146-161

**PRODUCT OVERVIEW** 164-241

# A FASCINATION FOR THE BATHROOM



Hartmut Dalheimer, Managing Director



Engelbert Himrich, Managing Partner



Sensuousness and sensibility – KEUCO’s passion for the bathroom runs through its veins, and this is evident in our products. A KEUCO bathroom awakens the emotions. It is an intimate place of well-being. It conveys elegance and luxury, and it combines aesthetics, ergonomics and functionality.

In no other room is this challenge more exciting and demanding than the bathroom. That is why this fascination still drives us forward. Since its founding in the year 1953, our company, which is still family-run today, has undergone a rapid and sustained transformation. From market leader for high quality bathroom accessories, KEUCO has evolved into the brand for the bathroom, with a wide assortment of furniture, fittings, accessories and mirror cabinets and from our early days we focused on offering concepts of complete bathroom furnishings.

Important factors contributing to our success are the contemporary, technically innovative products, the highest standard of quality, a clear orientation towards design, and state-of-the-art manufacturing facilities. Today, KEUCO products are sold around the world, and are market leaders in many areas. They are the result of intensive development work, the use of the best materials, and the most careful workmanship. We combine high-tech manufacturing and involved hand craftsmanship to achieve optimum results. KEUCO quality sets standards: Our products will convince you by their immaculate surfaces, maximum longevity, and perfect functionality. Each article is examined individually before being shipped out.

At KEUCO, the subject of design already played a pivotal role long before it even became a general topic of conversation. Our understanding of design involves striving to achieve classic-modern aesthetics that retain their contemporary feel, even after many years of use. Whether designed in-house or in cooperation with internationally recognized designers – KEUCO products are regularly distinguished by renowned awards.

But timeless design and long-lasting product quality are only two aspects of our sustainability philosophy. Equally important are responsible company management, and resource-saving production – with the help of our own water conditioning system for our electroplating plant, for example. We view the label “Made in Germany” as commitment to the kind of company management that aims to secure jobs in the long term.

KEUCO products are made in our own production plants in Hemer, Gütersloh and Bünde. Inland production provides us with a close proximity that is essential, so that we can develop and utilize the know-how of our employees on a long term basis, and so achieve seamless quality management. And that makes “Made in Germany” a promise of quality.

EDITION 400

# OUR IDEA OF FREEDOM OF DESIGN



# SENSUOUS SHAPES IN GLEAMING CHROME



A characteristic of EDITION 400 is its sensuously beautiful style. The gleaming chrome-plated fittings of the series present themselves like filigree sculptures. Virtually works of art, their extraordinary presence almost makes you forget their actual purpose. Conceived by the design agency Tesseraux+Partner in Potsdam and rewarded the "Design Plus" seal of quality, they are a prominent stylish element in KEUCO's full range of bathroom furnishings.



# ELEGANCE MADE IN GERMANY



The special thing about EDITION 400 fittings is the perfection in the details. The extravagant metallic surfaces of the fittings are an excellent example of this, where the warm bronze, champagne-coloured nickel, and opulent black – each either brushed or polished – so wonderfully underscore the exquisite character of EDITION 400.

This can be seen in the single-lever washbasin mixers in five sizes, with spout heights ranging from 80 mm to 290 mm for any kind of washbasin. A special feature integrated in the spout is the adjustable aerator, which is invisible from the outside. The EDITION 400 range of washbasin fittings also includes a pillar tap, a single-lever mixer with swivelling spout, a fitting for on-wall mounting, and a three-hole fitting.

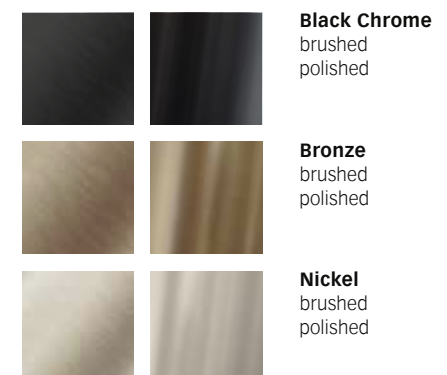

EDITION 400 fittings are also available with chrome-plated finish.

# STATUE FOR THE BATHROOM



KEUCO's sculptural EDITION 400 fittings speak a language of accentuation. The shower and bath fittings in different finishes provide the perfect excuse to spend a soothing time relaxing in the bathroom. Once again KEUCO has focused on the essentials here – both in the single-lever bath tub mixer as well as in the free-standing bath tub mixer with separate hand shower and practical glass shelf for bathroom utensils. It stands alone, but it can also be perfectly combined with a variety of bath tubs.



# DELICATE DESIGN ACCESSORIES

An aesthetic of filigree design, special functional features in the details, and high quality – this is how EDITION 400 accessories set special accents and create a sensuous atmosphere in the bathroom. With their practical functionality and elegantly slender appearance they pamper the user.

Harmoniously coordinated in design are also the lotion dispenser and tumbler holder – two perfectly matching companions. Combined with a utensil shelf, the accessories add homely comfort to the bathroom.





# UNLIMITED HOSPITALITY



Even though EDITION 400 is at home in the discerning private bathroom, it can be found more and more in the upscale hotel branch. For both areas of use, KEUCO has designed a remarkable towel rack with integrated towel holder. The filigree elegance of the softly rounded forms and the slender rectilinear contours is underscored by a unique combination of materials comprising coloured safety glass and high quality aluminium.

Despite its extreme robustness the 600 mm wide towel rack seems to hover lightly in front of the wall, throwing fascinating shadows. The four glass colours of dark grey, white, cashmere and truffle are perfectly coordinated with the colours of many of KEUCO's furniture pieces. An eye-catcher for lovers of the unique.



The KEUCO-typical variety of products offers a rich selection and four extravagant colours for discerning bathroom design: Produced using the PVD method, the accessories delight the eye with their warm bronze, champagne-coloured nickel or black chrome finish, either brushed or polished. For towel storage alone the assortment offers everything from towel hooks to towel rings and one or two-armed towel holders. A special feature of the double towel hook is that the towel is hung up from behind – ensuring that the design remains in full view.

# EXTRAORDINARILY PRACTICAL

EDITION 400 is an integral bathroom furnishing concept. In a stylish EDITION 400 bathroom with a feel-good ambience, the intelligent functionality of the accessories is icing on the cake. The shower shelf and shelf for corner installation are made of solid, silver anodized aluminium, so they are particularly unsusceptible to wear and tear and very durable. They come with or without glass wiper: integrated harmoniously in the design, it prevents shower utensils from falling. With their clear and minimalist design the shelves are perfect for every shower, but they are never in the way, despite the generous shelf space they offer.



# DESIGN IN EVERY DETAIL



Also around the toilet area, the EDITION 400 accessories are harmoniously integrated into the architectural environment of the bathroom design. With its particularly delicate design, the toilet paper holder demonstrates that it has the potential to become the next new classic. It is swivel-mounted, extremely delicate and can be easily attached to the wall. Even the wall-mounted toilet brush set impresses with its little secrets: On the outside it presents itself in fine, satin glass; inside it has a practical removable holder. The toilet brush hangs hygienically inside and it is concealed behind a lid.



FREEDOM IS  
HAVING A VARIETY  
OF POSSIBILITIES



# CLEAR LINES, IMPECCABLE DESIGN

The renowned design agency Tesseraux+Partner was commissioned to design EDITION 11. The fittings and accessories are in a class of their own, with a level of quality that you can see and feel and which pays off in the long-term.

The perfect chrome-plated washbasin fittings of EDITION 11 are optimally suited for every kind of use. Whether as a smaller model for the guest WC or especially high for washbasin tops and convenient hair-washing – they fulfil any wish regarding individual bathroom planning.

Produced using the PVD method, fittings with extravagant metallic surfaces in warm bronze, champagne-coloured nickel and opulent black – either brushed or polished – embody the beauty and lasting quality of EDITION 11.



Tesseraux+Partner  
Dominik Tesseraux





Three-hole fittings with a difference: Temperature regulation on the left, flow rate on the right. After adjusting to your own desired temperature, by pulling it up, the regulator can be returned to its initial position so that the temperature setting is retained.



As with all EDITION 11 washbasin fittings, the wall fitting with single-lever mixer has a flow rate limiter. It is available with three different length spouts.



The particularly appealing design of the freestanding bath tub mixer with a separate waterway for the hand shower is very impressive. A gem in the bathroom, it can be combined with numerous bath tubs and, no matter what one's personal interior design is, gives every bathroom a special touch.



Shower rail and hand shower reiterate the weightless elegance of the design of EDITION 11. In the four-hole bath-edge fitting with hand held pencil shower head the basic quadratic form of EDITION 11 is reflected in the decor disc. The bath tub mixer shines in immaculate chrome lustre, with flow and temperature regulators situated on the side.





# SELECTED SHAPES IN EVERY DETAIL



The KEUCO-typical variety of products offers a rich selection for attractive bathroom furnishing. This diversity of design is also manifested in the extravagant colour options of warm bronze, champagne-coloured nickel, and opulent black chrome, either brushed or polished. Alone for hanging up towels, the assortment ranges from the classic double towel holder to a chic one-armed towel holder and the vertical guest towel holder along with towel bin.

The guest towel holder is capable of holding up to six towels. The product range also includes an intelligent towel ring, which has an integrated spacer ensuring that damp towels can dry properly at a sufficiently ventilated distance away from the wall.





The chrome-plated shower basket comes optionally with a conveniently integrated glass wiper. It is easy to clean, and offers generous space for soaps, shampoos, and such. With a rounded inner surface and concisely crafted edges, the grab bar has an especially pleasant feel to it. Completing the EDITION 11 accessories are a soap holder with removable glass dish and a double tumbler holder, with mouth-blown tumblers made of genuine crystal glass.

All accessories add accents in bathroom design – aside from chrome-plated, also available in warm bronze, champagne-coloured nickel, and opulent black chrome, either matt or lusted.



PLAN

CONSISTENCY  
IN ITS MOST  
BEAUTIFUL FORM



# DYNAMIC INTERPRETATION OF A MODERN CLASSIC



With the PLAN S fittings concept, a new interpretation of the PLAN design is finding its home in the world's bathrooms. As a dynamic eye-catcher, the fittings are perfect for private or commercial use. The form of the angled spout of the single-lever mixer imitates the course of the water. Finishes in brilliant chrome, matt aluminium or high quality stainless steel make individual planning freedom a standard feature.

A visual and functional highlight is the in-wall single-lever basin mixer: the wall spout and control lever are combined in only one element. Clever installation features are included, thanks to the extremely thin installation unit and the depth compensation options in the wall.





All PLAN S fittings have a filigree, upward-pointing control lever that impresses both aesthetically and practically. Positioned to the side, the spout stays clean and dry even when using the lever with wet hands.

The single-lever basin mixer, which was developed specially for the Varicor® washbasin, is an eye-catcher in every respect. Sovereignly, it stands alone raised on a small base in the washbasin. Excellent design, with you in mind.



# CONSISTENTLY DYNAMIC



PLAN has always been known for its consistency. The angled spout, for example, is repeated as design component in other PLAN S elements. So when it comes to designing showers and baths, you have all the freedom in the world: for the bath it is either integrated in the on-wall fitting or it is available as freely-mounted bath filler on the wall.

And for installations with a minimalist look, the separate bath spout can also be perfectly combined with the in-wall elements of the IXMO concept. The shower mixer effortlessly brings PLAN's reduced look into the shower cubicle.



# TIMELESSLY MODERN AND INCREDIBLY VERSATILE



With 450 individual products, PLAN is one of the most extensive bathroom collections in the world. PLAN is as varied as the lifestyles of today and the breadth and depth of its large assortment enables individual, tailored solutions to be found. PLAN leaves nothing to be desired – not from an aesthetic or an ergonomic point of view, as the main focus of the PLAN care range offers an additional wide collection of barrier-free products to choose from.





PLAN blue fittings not only shine in terms of their impeccable surfaces and uncompromising functionality, but also with a consistently implemented sustainability concept. PLAN blue fittings help save water and energy in daily use; one example is the flow limiter in the washbasin mixer which limits to six litres per minute.

Thus, the new PLAN blue mixer with pivoting spout is not only a perfect solution for private use, but also for public areas. As a single lever mixer or pillar tap, they stand out in the slim design thanks to their precise design style and low water consumption.



# EYECATCHER IN EVERY BATHROOM



The wide range of surface variants multiplies the diversity of PLAN even more. Choose from chrome-plated, aluminium and stainless steel. Or between lotion dispensers as free-standing model (left) and the mounted model (top), suitable for installation in the washbasin or washtop.

# SUPERBLY DESIGNED EVERYDAY HEROES



PLAN series' accessories are popular worldwide and have proven their worth a million times over – in hotels, public buildings and private bathrooms. By constantly talking with architects, planners and installers, we are still discovering new places where demand exists for aesthetic and useful solutions.

The lotion dispenser with its practical single-handed operation and the cup for easy filling are worth showing off at the washbasin. The one-armed towel holder from the extended PLAN product range is available in two sizes: 340 and 450 mm.

# FUNCTIONALITY IN THE DETAILS



How much design and functionality can be incorporated in accessories? More than meets the eye – at least with the new PLAN shower shelf. Because, a glass wiper is integrated almost invisibly in the design. Available in brilliant chrome, matt aluminium and high quality stainless steel like all new PLAN accessories, the shower shelf optionally also comes without the glass wiper.

The perfect counterpart to this is the robust 135-degree-angled handhold. The integrated soap holder can be taken out for cleaning, and the grip is available as either right or left-sided variant. The shower shelf, glass wiper and soap dish are available in the colours dark grey, light grey or white.

The luxurious towel rack made of safety glass offers sufficient space for the shower towels of hotel guests.



# EVERYTHING CONSIDERED

PLAN accessories are at home all over the world, offering an extra amount of intelligent functionality anywhere they are found. The new 5 litre PLAN cosmetic waste bin finally solves the problem of that unsightly bit of bin liner that is always visible. Because, cleverly and elegantly, an exterior jacket in chrome, stainless steel, aluminium or white is slipped over the inner bin and liner. So, from the outside the bin liner is not visible.

Specially developed for commercial use, the double toilet paper holder with roll brake integrates itself seamlessly into PLAN tradition. And anyone who values comfort will appreciate the moist tissue box with sealing ring, allowing it to be closed airtight.



# HIGH QUALITY, CONVENIENT, BEAUTIFUL



The CARE products on this page can be flexibly combined for sanitation facilities. The PLAN railing system enables, among other things, a shower to be made barrier-free in a jiffy, if need be, thanks to the attachable tip-up seat. The firmly mounted soft seat, 450 mm wide – also available in 360 mm width – meets the requirements of DIN 18040-1.

# AMENITY, OPEN TO THE PUBLIC



PLAN INTEGRAL recessed installation modules for the washbasin and WC are perfect for highly frequented public sanitary areas. Not only do they convince with advantages such as easy cleaning, sturdiness and easy refilling, but also through their elegant and unobtrusive design.

At the top left two washbasin modules – tissue box dispenser and paper towel dispenser along with waste bin. Beside that a WC module with sanitary bag dispenser and sanitary waste bin. In total there are five different modules available, which can be flexibly combined according to need.

ELEGANCE

# VARIETY AS A PRINCIPLE



# THE DESIGN CLASSIC WITH PROFILE

Initially begun in 1967 purely as line of accessories, ELEGANCE established itself internationally over the decades and became the biggest selling bathroom series in the world. Today, ELEGANCE offers a comprehensive assortment with a wide array of models. The demand for ELEGANCE products still remains steady today thanks among other things to its timelessly modern design.



.molldesign  
Reiner Moll



# EFFUSIVE FLEXIBILITY



Right angles and straight lines, coupled with vibrant curves. As in the entire collection, ELEGANCE fittings convince by their striking, classic-modern design.





# HIGHLIGHTS



ELEGANCE accessories bring aesthetics, ergonomics and ease of cleaning under one umbrella. All metal parts are chrome-plated to a high standard of quality. The soap foam dispenser is made of matt opal glass; the lotion dispenser and the toothbrush tumbler are made of matt crystal glass. The matt crystal dish can be removed for cleaning from the soap dish on the right.





The ELEGANCE rail system brings elegant comfort into the bathroom: The rail system can be combined as needed with the existing bathroom furnishings.

The matching shower curtains from KEUCO are anti-bacterial, fungicidal, antistatic and available in different colours and sizes.



COLLECTION MOLL

# NEW TIMELESSNESS



# INSPIRATION AND INNOVATION

The COLLECTION MOLL lets fittings and accessories shine in a new light: An inspiring design, highest innovative details and needless to say, the complete KEUCO competency for precise workmanship and durable quality. The unobtrusive, sleek design gives the collection a lightless and timeless beauty that bears the signature of the designer Reiner Moll, and harmonises with numerous KEUCO washbasin and furniture ranges.



.molldesign  
Reiner Moll



# FREEDOM LIES IN THE VARIETY



COLLECTION MOLL washbasin fittings captivate just as much through their premium “Made in Germany” quality as they do through their attractive design. The exceptionally high quality materials and workmanship make them a lasting investment. Aside from their durable engineering and an appearance that lends itself to versatile combination, they also feature functional elements.



# IDEAS RIGHT DOWN TO THE LAST DETAIL



Whether for corners or walls, the shower baskets of COLLECTION MOLL have a removable, break-proof synthetic insert – hygienic and easy to clean.

The sponge basket, with its integrated, retractable shower squeegee, demonstrates what aesthetically technical innovations could look like. After use, the shower squeegee disappears into the sponge basket, which is open at the bottom so water can drain away.





One can hang up, hang up or hang up a towel: From a towel ring and double hook, via a single or double-armed towel holder. The COLLECTION MOLL offers a generous collection for an attractive bathroom design style. The towel ring, for example, is made entirely in one piece and its seamless aesthetic stands out. The ergonomically designed towel rail invites to be touched.





Maximum functionality and attention to detail are also special features of COLLECTION MOLL products for the WC – from the toilet paper holder with or without lid, right to the WC brush set, as a wall or floor model: For example, the toilet brush set, in which the brush hangs in the brush holder and therefore avoids looking directly at the brush.

IXMO

LESS IS MORE



# MINIMALISM IN THE SHOWER



With the new member of the IXMO family, the motto “less can do more” has never been so true. IXMO SOLO is truly a functional wonder: The impressive thing about this little module is its intelligent combination of innovative technology and minimalist design.

The result is a fitting that uniquely combines a single-lever mixer and hose connection. Minimum installation work, maximum convenience – because only IXMO SOLO and no further water-conducting elements is all that is required for a complete shower solution.

The IXMO SOLO product design is so consistent and small that a picture of perfection is produced in every shower. And with the round or rectangular decor disc options, IXMO SOLO also perfectly matches all other KEUCO lines.



# WATER WILL FIND ITS WAY

For planners and architects, the IXMO concept isn't just about minimalist design, it is especially about maximum design freedom. Because, with the existing IXMO components and the new IXMO SOLO single-lever mixer, different installation types can now be impressively realised for the private household, the multi-family unit or the hotel branch.



The **one-way installation** with IXMO SOLO reduces the installation work to one water-conducting element on the wall.



For the **two-way solution** with two outlets, just two proven IXMO modules are required on the wall.



For the **three-way installation**, only two elements are needed on the wall, thanks to the 3-way stop and diverter valve.

IXMO

# COMPRESSED FUNCTIONS: 3 BECOME 1



The central concept behind the IXMO fittings for the shower is the concentration of functionality. An IXMO single-lever mixer or thermostat is always combined with multifunctional IXMO elements which, in addition to connections for one, two or three water channels, also compactly unite other functions such as a hose connection, hand shower bracket, stop cock, or selector. This allows the number of products on the wall to be reduced, and enhances the appearance at the same time. Since the individual fitting units can be freely positioned, IXMO offers a high standard of design freedom.

With the IXMO fittings for the shower, KEUCO once again demonstrates its high standard of innovation in design and technology.





At the centre of the IXMO fitting is a single-lever mixer or thermostat which can be combined with multifunctional fitting elements in a coordinated design. The single-lever mixer for the shower is available with its own handle, but it is also available in other design variations to match all KEUCO fittings series. In addition to a chrome-plated, stainless steel, or aluminium finish, all fitting elements are also available in warm bronze, champagne-coloured nickel and opulent black – either brushed or polished.



# A QUESTION OF COMBINATION



Design for multiple styles: Another special benefit offered by IXMO bath fittings is the formal lightness and the clear, geometric contours. They integrate well in a diverse array of furnishing styles. Thanks to the multifunctional features of the modules, IXMO celebrates a fusion between design and function, pointing the way to the future.





IXMO

# IXMO GOES WASHBASIN

If it works impressively in the shower, it will be perfect for the washbasin, too. As such, we have now transferred the IXMO principle to an integrated washbasin fitting. When the wall spout and the single-lever mixer are combined in only one fitting element, as shown here, planning freedom benefits. The in-wall fitting comes with either a round or square decor disc and lends a luxurious, tidy feel to the wash area.

Minimal also aptly describes the installation work involved for all IXMO modules. HVAC pros only need to install one in-wall base structure. With the clever depth-compensation feature, the already shallow installation depth of the washbasin fitting can be flexibly varied anywhere from 70 to 100 mm. Maximum installation intelligence.

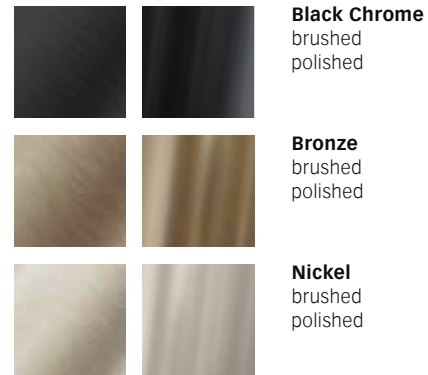

IXMO fittings are also available with chrome-plated, stainless steel or aluminium finishes.

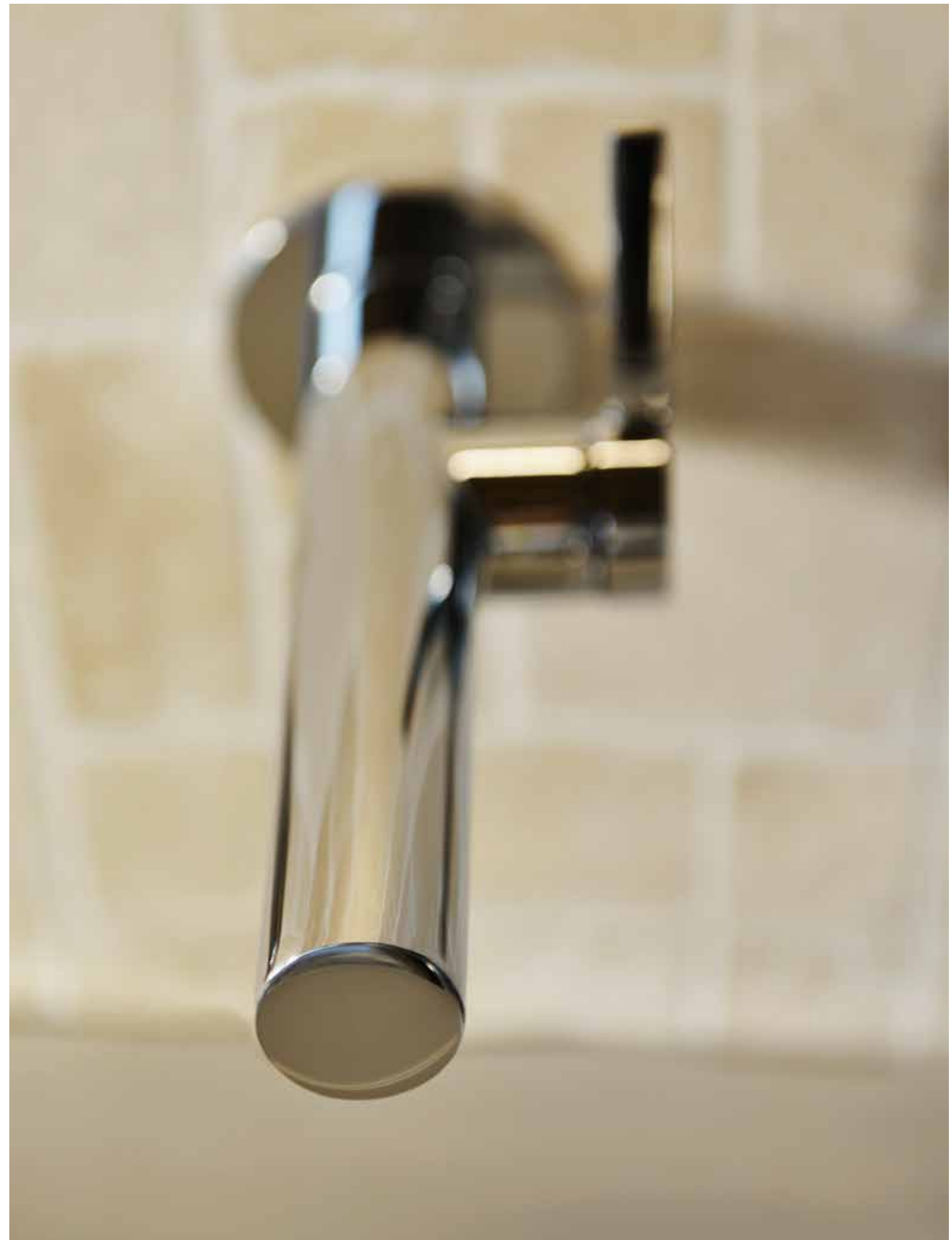

# WATER IN ITS HEALTHIEST FORM



The element of water has always fascinated people. It is particularly fascinating when it takes the form of a waterfall. The aesthetic meTime\_spa dousing shower can bring this experience into your own bathroom. The feeling of taking a shower under a waterfall – of allowing the primal power of water act on you – is relaxing for your mind and soul, too. The water treatments inspired by Sebastian Kneipp are perfect for allowing the soothing and relaying effects of water fall on your skin and muscles. With the SPA hose, you can experience the health-promoting alternating hot and cold showers in the privacy of your own bathroom at home and at your leisure.

# SUPERIOR SHOWERING



Once you see one of the new head showers, you'll ask yourself: How on earth did the KEUCO designers do that? After all, the head section of the shower is an unbelievable 6.5 mm thick. You'll be amazed while showering, too. The flat shower head produces a magically uniform rain pattern. And with its round or square form in various sizes it will be perfect for your individual shower plans.

# ROOM FOR COMFORT



Design and comfort are becoming increasingly important in the shower. The KEUCO shower seat offers an elegant solution for this. Made of a soft and body-friendly material, it has a pleasant and warm feel to it. The surface material ensures that one sits securely, and it is also extremely robust and easy to care for and clean. With a width of 450 mm and a depth of 330 mm, it offers ample space. The concealed, extremely robust wall mount can support up to 150 kg. Available in the colours dark grey, white, cashmere or truffle, it is a current trend-setter and is a great match for many KEUCO bathroom furnishings.

Shower set IXMO and Accessories PLAN



# SHOWER EXPERIENCE FOR THE SENSES





Comfort and sensuality are at the forefront of this very special solution for shower fittings. The multi-functional concealed thermostat meTime\_spa unites everything which one needs for an extraordinary shower experience – not only in an elegant but also innovative way.

The fitting comes in various sizes and, besides chrome-plated control elements to adjust the flow and temperature of the water, it also offers aluminium shelving on one or more levels. So that it integrates into your own personal interior design style in the best possible way, the glass panel is available in white, anthracite, petrol, truffle or cashmere.



Tesseraux+Partner  
Dominik Tesseraux



# LITTLE HELPERS WITH A BIG IMPACT





# QUALITY AND DESIGN FOR HIGH PERFORMANCE

High-quality materials, excellent workmanship and perfect surfaces – these are the common denominators of all KEUCO accessories. They allow you to perpetuate and effectively accentuate your own personal style of aesthetics in your home. Thanks to their large variety, KEUCO accessories offer the right solution for every kind of bathroom.



# CONSISTENT COMBINATION MADE EASY



At KEUCO accessories are much more than just useful additions. It is also important that they can be blended in any combination to form a harmonious visual whole, perfectly coordinated to the characteristic design of the rest of the bathroom furnishings. EDITION 300 does this beautifully.

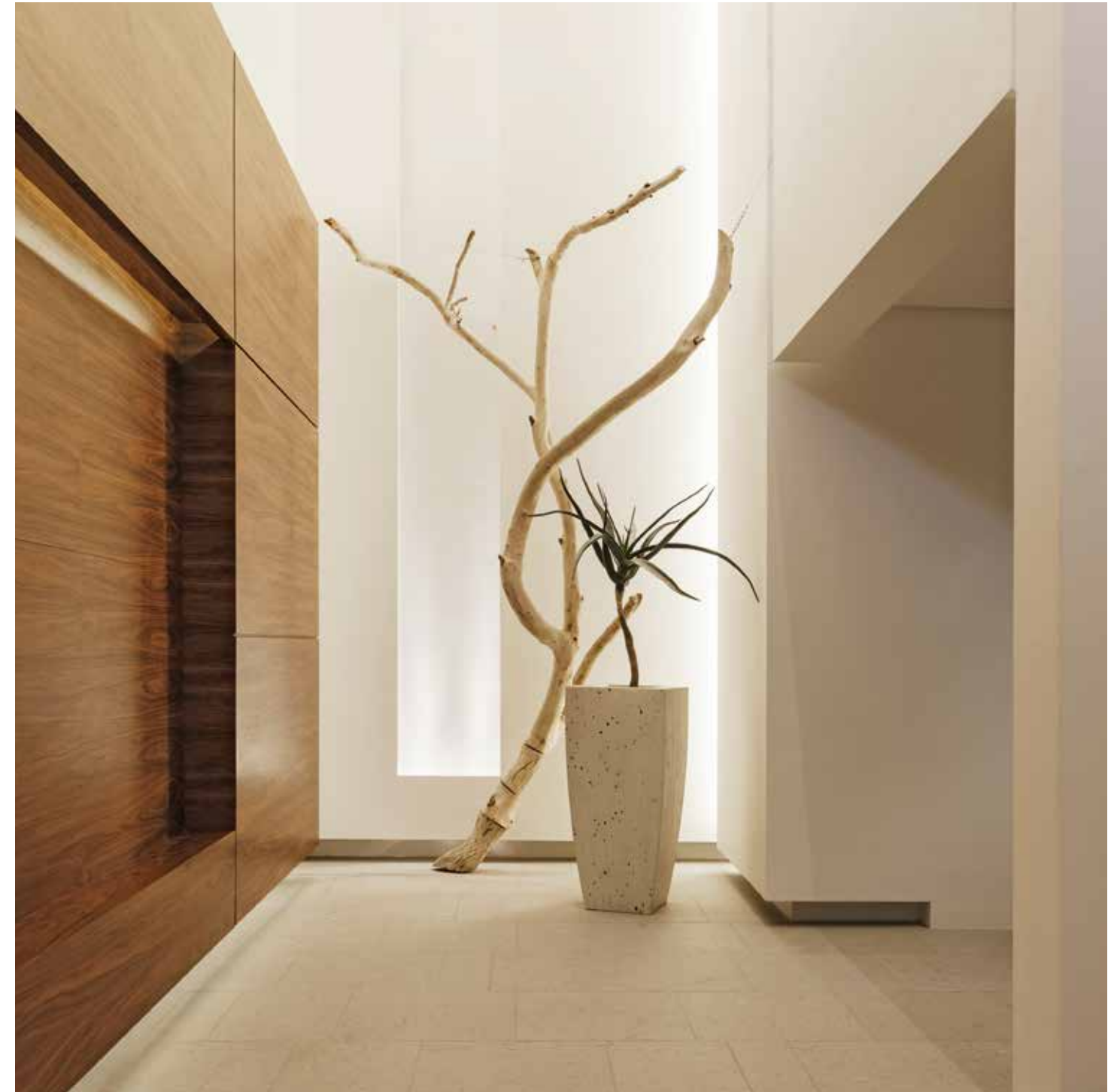



Elegance in circular and spherical shapes: With their decorative discs, ASTOR accessories provide an aristocratic flair in the bathroom. The lotion dispenser made of matt opal glass, the tumbler holder with crystal glass tumbler, the soap holder with crystal dish, and toilet paper holder with lid give out a clear message of stylish confidence.





Urban chic, not just for townhouses: CITY.2 brings functional elegance into the bathroom. The series satisfies a wide range of needs, thanks to the large variety of products. On the left the double holder with lotion dispenser and crystal glass tumbler, and on this side the towel holder and towel ring.

SMART.2

# SIMPLY PRACTICAL

SMART.2 accessories make a good impression all round the washbasin. Both the tumbler holder and the soap holder impress with their genuine, high quality crystal glass, while the lotion dispenser in white opaque plastic is practical to use.





The practical two-armed towel holder can be swivelled and the holder of the towel ring can be mounted either to the left or to the right. This means that a decision about the mounting side only needs to be made during final installation. The holder is simply inserted on the desired side and snaps on – no bolts or screws are necessary.





With its new materials and functionality, SMART.2 has lots to offer even for the shower and WC area. The spacious shower basket has a high edge, so no shower utensils can fall out. The robust grab bar can bear a load of up to 115 kg. Matching towel rails in widths of 600 mm and 800 mm and a towel hook round off the assortment.



The brush holder of the toilet brush set is made of easy-to-clean white plastic. The metal arm of the toilet paper holder can be mounted either to the left or to the right. Depending on habit or the local conditions, the arm is simply inserted on the desired side and snaps in. Fixed in place and finished! For this the spare paper holder is a perfect match.







The whole universe of accessories: Our universal articles leave no wish unfulfilled because they offer the proper solution for every need. They are just as suitable for the private area as they are for public areas. Thanks to their practical and functional design and the different variations, they blend harmoniously into every bathroom.

Strong performance: A grab bar with integrated soap dish. Top, moist tissue box, tissue box, and a tip-up seat for maximum comfort while in the bathroom.



Practical, high quality and compatible with any style – discover the diversity of KEUCO's universal articles: Whether toilet paper double holder (right), soap foam dispenser as free-standing model (large picture) or the free-standing models for the WC. The brilliant chrome surfaces of the brush holders and their solid material mean that you can really feel the quality of the workmanship. The solid base with anti-slip mat ensures that it is stable.



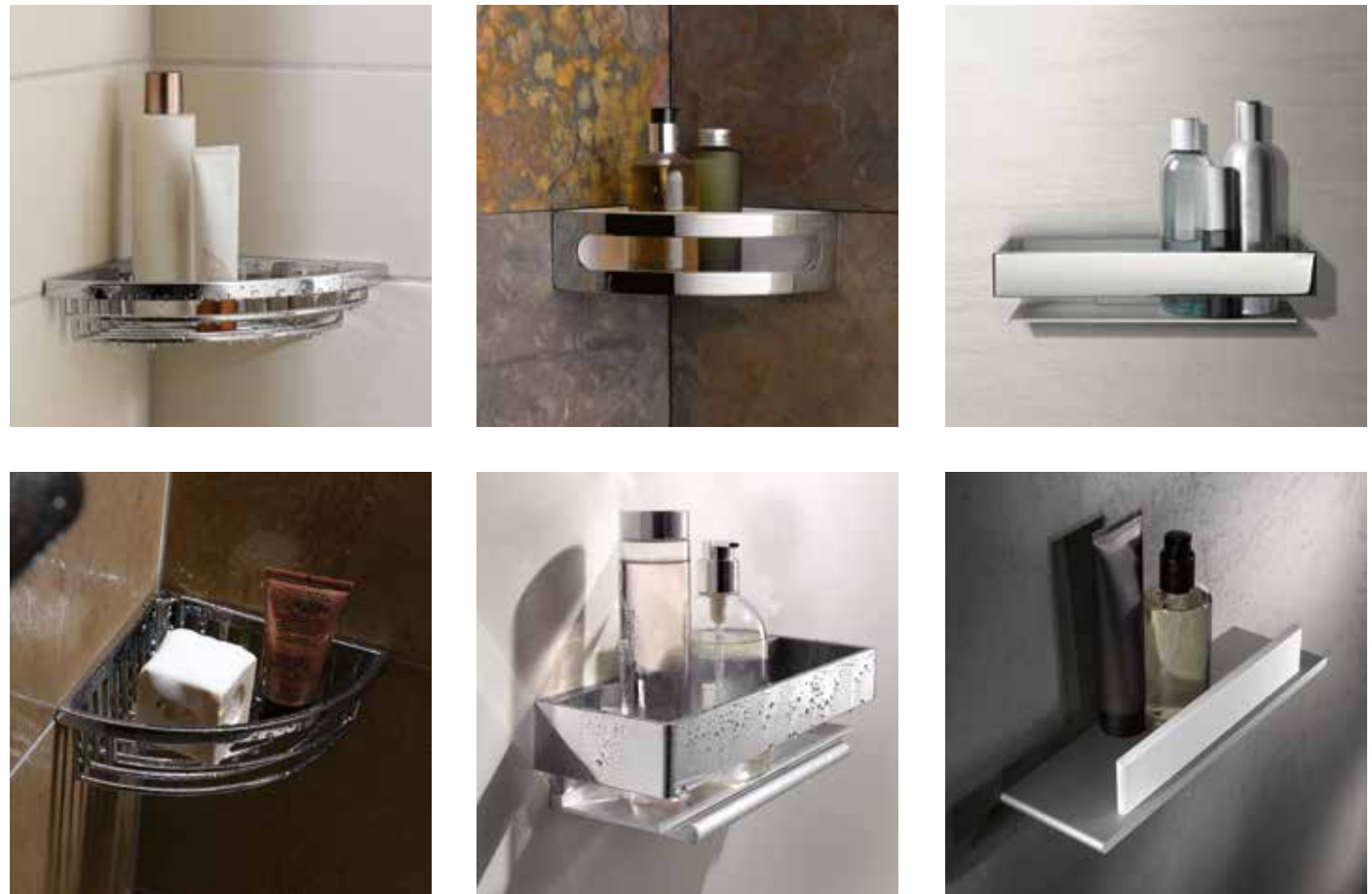

Durable, easy-to-clean – and simply beautiful. The huge variety of KEUCO accessory designs carries on with the soap wire baskets. The different shapes, surfaces, dimensions and variants for corner or wall mounting offer the right solution for every hotel bathroom – including practical details such as an integrated glass squeegee (right bottom), which can be easily taken out from the front.



SOAP WIRE BASKETS



Sometimes simply functional, sometimes full of useful surprises as can be seen on the right with an integrated glass squeegee: KEUCO soap and sponge baskets enchant with their wealth of variants.



LIGHT AND MIRROR

# BEAUTY HAS TWO ALLIES: LIGHT AND MIRROR



# CREATE THE PERFECT SETTING FOR YOU AND YOUR BATHROOM



As a practical utensil for daily beauty care, the glare-free iLook\_move cosmetic mirror shines with its slender, refined design in round or square form, with illuminated or unilluminated mirror surface. The hinge technology works brilliantly too: The height, distance, inclination and lateral angle can each be adjusted with a simple action. In the illuminated model with control panel on the glass surface, this innovative mirror with fivefold magnification designed by Tesseraux+Partner offers two different light modes: A daylight function, like the ones that can be found in professional beauty institutes, and a second luminous colour in flattering warm white – ideal for the perfect evening makeup, for example. Unique to date is the infinitely variable adjustment feature of both luminous colours.

Whether with a luminous colour or a control panel on the glass surface with sensor system, the iLook\_move is simultaneously high tech for beauty care and a perfect masterpiece. The LED lamp is long-lasting and has minimal power consumption. If flush-mounted fitting is not an option, a version is also available with a wall wart.









Now that's an eye-catcher: Cosmetic mirrors of every kind and with many kinds of adjustment options. After all, not only should your bathroom look good, but you should too.

# PURE DESIGN – THE LATEST TECHNOLOGY



The innovative illuminated mirrors are a special highlight. The EDITION 400 illuminated mirror presents itself with remarkably elegant slenderness and a surrounding aluminium edge. Customized dimensions are available on request. Its secret: A special light-conducting material conducts the light of the LED to the surface and provides the ideal lighting for the room or face at all times. With unobtrusive and intelligent sensor controls the light can be dimmed and the light colour altered in an infinite number of steps: From bright-white daylight for ideal, day-to-day beauty care, right to a warm-white light, ideal for perfect evening make-up or an atmospheric bathing ambience. Moreover in every light situation the LED lighting is glare-free and long lasting, and it also saves energy and is maintenance free.

But the EDITION 400 light mirror can do much more: It is optionally available with mirror heater, which is a practical feature that prevents the mirror from misting up after taking a shower. Of the highest technical standard, the sensor-controlled mirror heater switches off again automatically 20 minutes after being switched on.



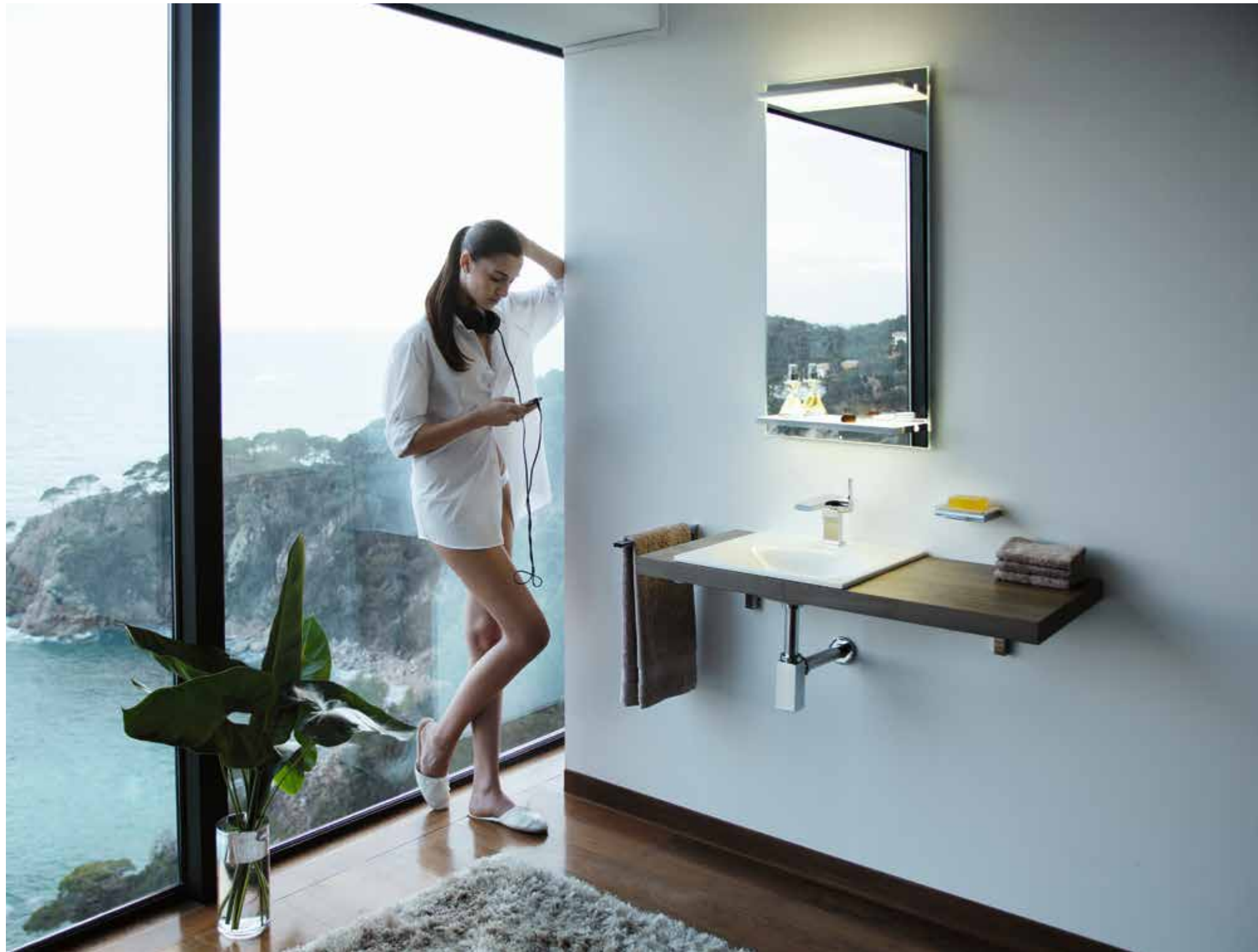

The light mirror for the guest bathroom not only presents a handy, but also elegant innovation: Two LED illuminated panels, which at the same time serve the function as a shelf.



# ATTRACTIVE FROM EVERY ANGLE

The light mirrors carry on EDITION 300's traditionally clear and geometric language of form. Available in different formats, they satisfy all your individual needs and illuminate the face glare-free from every angle. With four fluorescent tubes concealed behind the frame, this is something you can depend on. EDITION 300 even has a format suitable for the guest WC. The vertical lighting here produces a pleasant light.



# PICTURE PERFECT

Like all KEUCO products, the PLAN crystal and light mirrors feature both aesthetic as well as practical components. Combined with the linear furniture, they form a harmonious whole. The surrounding frames emphasize the perfectly-coordinated colours to great effect. Although it must be said that the lacquer finish of the premium aluminium frame is still very durable and easy to care for.

Innovative LED lights are integrated in the upper edge of the PLAN mirror frame. Thanks to the careful sorting of the individual LED modules, the effect of the light is very harmonious, ensuring perfect illumination of the face. The control unit is integrated in the slender frame and offers very intuitive operation. The light colour can be varied, and the washbasin and main lighting can be switched on or off and dimmed separately. The next time it is switched on again the intelligent electronics remember the most recent lighting scenario. A practical mirror heater is available as a further option.



Heater



Warm-white  
light colour



Daylight-white  
light colour



Washbasin  
lighting  
(bottom)



Main lighting  
(top)



On/Off





# THE SECRET OF BEAUTY IS TO BE CAPABLE OF SEEING IT



With their wide variety of sizes, ELEGANCE light mirrors can be adapted to every kind of furnishing concept – from guest WC to family bathroom with double washbasin. Their rounded corners harmoniously reflect the soft lines of ELEGANCE. Illumination for your face and the room can be switched separately.

# LIGHT AS REQUIRED



The ROYAL 60 furnishing concept offers you an array of aesthetically pleasing light mirrors. The light radiating out of the vertical light strips can be switched separately as mirror or room light.





# GOOD DESIGN REFLECTS ITS TIME



Basin mixer PLAN BLUE and soap holder PLAN



ROYAL REFLEX light mirrors are framed by lateral light modules which illuminate the face evenly. They are available in widths up to 1300 mm.

In the ROYAL REFLEX 2, LED modules radiate a 3000 kelvin warm-white light. The additional washbasin illumination sets accents on the fitting and washbasin. An intelligent rotary dimmer is used to control both light sources.



WE'RE PASSIONATE  
ABOUT FLAWLESS  
PRODUCTS



# PRODUCT OVERVIEW

## EDITION 400

Surfaces:



chrome-plated



bronze polished



bronze brushed



nickel polished



nickel brushed



black chrome polished



black chrome brushed



51508



51504



51504



51502



51502



51502



51505



51509



51515

### 51508

#### Pillar tap 80

without pop-up waste,  
1-hole installation, lever head action 90°  
with ceramic sealing gaskets,  
aerator SLIM SSR M 24x1, adjustable flow angle,  
flow rate limited to 7,6 l/min.

### 51502

#### Single lever basin mixer 150

with/without pop-up waste 1 1/4 Inch,  
1-hole installation, cartridge mixer  
with ceramic sealing gaskets,  
aerator SLIM SSR M 24x1,  
adjustable flow angle,  
flow rate limited to 7,6 l/min.

### 51505

#### Single lever basin mixer 150

with/without pop-up waste 1 1/4 Inch,  
spout swivelling +/- 45°,  
1-hole installation, cartridge mixer  
with ceramic sealing gaskets,  
aerator SLIM SSR M 24x1, adjustable flow angle,  
flow rate limited to 7,6 l/min.

### 51504

#### Single lever basin mixer 80

with/without pop-up waste 1 1/4 Inch,  
1-hole installation, cartridge mixer  
with ceramic sealing gaskets,  
aerator SLIM SSR M 24x1, adjustable flow angle,  
flow rate limited to 7,6 l/min.

### 51502

#### Single lever basin mixer 240

with/without pop-up waste 1 1/4 Inch,  
1-hole installation, cartridge mixer  
with ceramic sealing gaskets,  
aerator SLIM SSR M 24x1,  
adjustable flow angle,  
flow rate limited to 7,6 l/min.

### 51509

#### Single lever bidet mixer

with pop-up waste 1 1/4 Inch,  
1-hole installation, cartridge mixer  
with ceramic sealing gaskets,  
aerator cache TT M 18,5x1  
flow rate limited to 7,6 l/min.

### 51504

#### Single lever basin mixer 120

with/without pop-up waste 1 1/4 Inch,  
1-hole installation, cartridge mixer  
with ceramic sealing gaskets,  
aerator SLIM SSR M 24x1, adjustable flow angle,  
flow rate limited to 7,6 l/min.

### 51502

#### Single lever basin mixer 290

without pop-up waste,  
1-hole installation, cartridge mixer  
with ceramic sealing gaskets,  
aerator SLIM SSR M 24x1,  
adjustable flow angle,  
flow rate limited to 7,6 l/min.

### 51515

#### Three-hole basin mixer 150

with/without pop-up waste 1 1/4 Inch,  
3-hole installation, ceramic valve for temperature  
regulation and valve for flow control,  
aerator SLIM SSR M 24x1, adjustable flow angle,  
flow rate limited to 7,6 l/min.



51516



51520



51524



51530



51530



51545

**51516**  
**Single lever basin mixer**  
 concealed fitting DN 15,  
 cartridge mixer with ceramic sealing gaskets  
 and temperature control,  
 aerator SLIM SSR M 24x1, adjustable flow angle,  
 flow rate limited to 7,6 l/min.  
 Projection: 187, 219, 265 mm  
 (essential for installation:  
 Rough part Article No. 59916  
 to be ordered separately)

**Note:**  
 flexible arrangement of lever and spout possible  
 during assembly.

**51530**  
**Bath tub mixer**  
 4-hole bath filler,  
 ceramic valve for temperature regulation  
 and valve for flow control,  
 aerator SLIM SSR M 24x1, adjustable flow angle,  
 pull-out pencil hand shower,  
 with backflow preventer  
 Projection: 180, 220 mm  
 (suitable fixing block Article No. 51130  
 to be ordered separately)

**51520**  
**Single lever bath tub mixer**  
 exposed,  
 cartridge mixer with ceramic sealing gaskets,  
 with automatic diverter, aerator SLIM SSR M 24x1,  
 adjustable flow angle, with backflow preventer

**51530**  
**Bath tub mixer**  
 3-hole bath filler,  
 ceramic valve for temperature regulation  
 and valve for flow control,  
 pull-out pencil hand shower,  
 with backflow preventer,  
 (suitable fixing block Article No. 51130  
 to be ordered separately)

**51524**  
**Single lever shower mixer**  
 exposed,  
 cartridge mixer with ceramic sealing gaskets,  
 with backflow preventer

**51545**  
**Bath spout DN 20**  
 suitable for all concealed fittings  
 Projection: 152, 202 mm



51571



51572

51572



51573



51574



51527



51585

51587

**51571**  
**Single lever shower mixer**  
 concealed fitting,  
 set complete with: handle, sleeve, rosette  
 and installation unit,  
 suitable for rough part no. 59970 (Flexx Boxx)  
 (Flexx Boxx to be ordered separately)

**51573/51574**  
**Thermostat battery**  
 concealed fitting  
 with ceramic cut-off valve (51573),  
 with ceramic cut-off and switch valve (51574),  
 safety cut-off at 38 °C,  
 set complete with: handle, sleeve, diverter,  
 rosette and installation unit,  
 suitable for rough part no. 59970 (Flexx Boxx)  
 (Flexx Boxx to be ordered separately)

**51572**  
**Single lever bath tub and shower mixer**  
 concealed fitting,  
 with/without safety device,  
 set complete with: handle, sleeve, diverter, rosette  
 and installation unit,  
 suitable for rough part no. 59970 (Flexx Boxx)  
 (Flexx Boxx to be ordered separately)

**51527**  
**Single lever bath tub mixer**  
 floor-mounted/free standing,  
 cartridge mixer with ceramic sealing gaskets,  
 with aerator,  
 complete with round pencil shower,  
 shower hose 1250 mm and shelf  
 (Floor-mounting set article no. 51127  
 to be ordered separately)

**51585**  
**Hand shower sliding rail**  
 consisting of:  
 – wall rail, 900 mm  
 – sliding bracket for hand shower  
 – height adjustment via handle,  
 tilting angle adjustable  
 – spacer disc (5 mm)

**51587**  
**Hand shower sliding rail set**  
 consisting of:  
 – rail with sliding bracket, 900 mm  
 – height adjustment via handle,  
 tilting angle adjustable  
 – spacer disc (5 mm)  
 – hand shower with normal, soft and massage jet  
 – shower hose, 1600 mm



51580 56080



59986/51688 59986/51689 51686/51688 51686/51689



54947



54995



51591

**51580**  
**Hand shower**  
with anti limescale device,  
with normal, soft and massage jet  
with ECO AIR function,  
restricted flow rate 10 l/min.

**56080**  
**Round pencil hand shower**  
with normal jet

**54947**  
**Wall outlet for shower hose DN 15**  
suitable for all concealed fittings

**59986/51688**  
**Head shower with wall outlet DN 15**  
with shower head rail,  
restricted flow rate 15 l/min.  
Projection: 300, 450 mm  
Ø 200 mm  
Ø 250 mm  
Ø 300 mm  
Only available in chrome finish

**59986/51689**  
**Head shower with ceiling outlet DN 15**  
with shower head rail,  
restricted flow rate 15 l/min.  
Projection: 100, 300 mm  
Ø 200 mm  
Ø 250 mm  
Ø 300 mm  
Only available in chrome finish

**54995**  
**Shower hose DN 15**  
both ends fitted with conical nut  
and twist-protection  
1250, 1600, 2000 mm

**51686/51688**  
**Head shower with wall outlet DN 15**  
Ø 180 mm, with shower head rail,  
restricted flow rate 15 l/min.  
Projection: 100, 300 mm

**51686/51689**  
**Head shower with ceiling outlet DN 15**  
Ø 180 mm, with shower head rail,  
restricted flow rate 15 l/min.  
Projection: 100, 300 mm

**51591**  
**Wall bracket for hand shower**  
for shower hoses with conical nuts



11501



11507



11510



11514



11515



11518/11519



11520/11522



11521

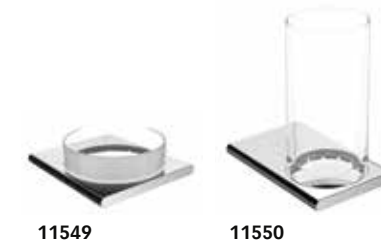

11549

11550



11552

11555

**11501**  
**Towel rail**  
600, 800, 1000 mm

**11514**  
**Towel hook**  
60 mm

**11515**  
**Towel hook**  
double

**11521**  
**Towel ring**

**11507**  
**Grab bar/Towel rail (USA)**  
350 mm

**11518/11519**  
**Towel holder**  
2-arms, fixed  
Projection: 340, 450 mm

**11549**  
**Utensil tray**  
crystal glas matt

**11550**  
**Tumbler holder**  
complete with crystal glass tumbler

**11510**  
**Shelf**  
with crystalline glass shelf  
Dimensions:  
700 x 120 mm  
1050 x 120 mm  
1400 x 120 mm

**11520/11522**  
**Towel holder**  
1-arm, fixed  
Projection: 340, 450 mm

**11552**  
**Lotion dispenser**  
complete with crystal glass tumbler, matt  
Capacity: approx. 150 ml

**11555**  
**Soap holder**  
complete with crystal glass dish, matt



11553



11554



11556



11558



11559



11575



11562

11563



11564



11557

**11553**  
**Double holder glass/lotiondispenser**  
complete, comes with:  
1 x crystal glass tumbler  
1 x lotiondispenser for liquid soap  
Capacity: approx. 150 ml

**11558**  
**Shower shelf**  
aluminium silver-anodized (E6 EV1)

**11562**  
**Toilet paper holder**  
open form,  
for 120 mm wide paper rolls

**11563**  
**Spare paper holder**

**11554**  
**Double holder glass/utensil tray**  
complete, comes with:  
1 x crystal glass tumbler  
1 x utensil tray, crystal glass matt

**11559**  
**Shower shelf**  
aluminium silver-anodized (E6 EV1)  
with integrated glass scraper (white)

**11564**  
**Toilet brush set**  
complete with crystal glass insert matt, detachable  
opaque synthetic insert, brush with handle and lid,  
spare brush head

**11556**  
**Double holder glass/soap**  
complete, comes with:  
1 x crystal glass tumbler  
1 x crystal soap dish, matt

**11575**  
**Towel rack**  
with panel made of ESG glass and  
shelf aluminium silver-anodized  
Glass colour variations:  
– anthracite clear  
– truffle clear  
– cashmere clear  
– white clear  
Width: 600 mm

**11557**  
**Shower shelf for corner installation**  
aluminium silver anodized  
Dimensions: 245 x 242 mm

**11557**  
**Shower shelf for corner installation**  
with integrated glass scraper,  
aluminium silver anodized/white  
Dimensions: 245 x 242 mm

Surfaces:



51102



51102



51104



51109



51115



51116

**51102**  
**Single lever basin mixer 150**  
with/without pop-up waste 1 1/4 Inch,  
1-hole installation, cartridge mixer  
with ceramic sealing gaskets  
aerator SLIM SSR M 24 x 1  
adjustable flow angle +/- 8°  
Flow rate limited to 7,6 l/min.

**51109**  
**Single lever bidet mixer**  
with pop-up waste 1 1/4 Inch,  
1-hole installation, cartridge mixer  
with ceramic sealing gaskets,  
aerator cache TT M 18,5 x 1  
Flow rate limited to 7,6 l/min.

**51102**  
**Single lever basin mixer 250**  
without pop-up waste,  
1-hole installation, cartridge mixer  
with ceramic sealing gaskets  
aerator SLIM SSR M 24 x 1  
adjustable flow angle +/- 8°  
Flow rate limited to 7,6 l/min.

**51115**  
**Three hole basin mixer 150**  
with/without pop-up waste 1 1/4 Inch,  
3-hole installation, ceramic valve for temperature  
regulation and valve for flow control  
Flow rate limited to 7,6 l/min.

**51104**  
**Single lever basin mixer 110**  
with/without pop-up waste 1 1/4 Inch,  
1-hole installation, cartridge mixer  
with ceramic sealing gaskets  
aerator SLIM SSR M 24 x 1  
adjustable flow angle +/- 8°  
Flow rate limited to 7,6 l/min.

**51116**  
**Single lever basin mixer**  
wall-mounted concealed fitting  
cartridge mixer with ceramic sealing  
gaskets and temperature limiter  
aerator SLIM SSR M 24 x 1  
adjustable flow angle +/- 8°  
Flow rate limited to 7,6 l/min.  
(essential for installation: rough part  
article no. 51116 to be ordered separately)

**Note:**  
flexible arrangement of lever and spout possible  
during assembly.



51120



51127



51126



51171



51172

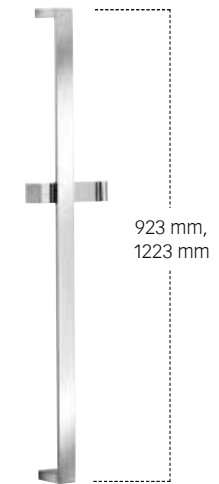

51185



51130



51130



51145



51173



51174

**51120**  
**Single lever bath tub mixer**  
 exposed fitting  
 shut-off valve and diverter with ceramic sealing gaskets, mixing valve with ceramic sealing gaskets, wall bracket for shower hose DN 15 (Flow rate limited to 12 l/min.)  
 with backflow preventer  
 depth gauge 150 +/- 14 mm  
 aerator M 28 x 1  
 flow rate approx. 23 l/min.

**51130**  
**Bath tub mixer**  
 4-hole bath filler  
 ceramic valve for temperature regulation and valve for flow control  
 aerator M 28 x 1  
 pull-out pencil hand shower  
 with backflow preventer  
 Projection: 180, 220 mm  
 (suitable fixing block article no. 51130 to be ordered separately)

**51127**  
**Single lever bath tub mixer**  
 floor-mounted/free standing  
 cartridge mixer with ceramic sealing gaskets, complete with round pencil shower and shower hose, 1250 mm  
 (Floor-mounting set article no. 51127 to be ordered separately)

**51130**  
**Bath tub mixer**  
 3-hole bath filler  
 ceramic valve for temperature regulation and valve for flow control  
 pull-out pencil hand shower  
 with backflow preventer  
 (suitable fixing block article no. 51130 to be ordered separately)

**51126**  
**Thermostat battery for shower**  
 exposed fitting  
 handle with 50% water consumption regulation, safety cut-off at 38 °C,  
 with backflow preventer

**51145**  
**Bath spout DN20**  
 suitable for all concealed fittings  
 Projection: 146, 196 mm

**51171**  
**Single lever shower mixer**  
 concealed fitting  
 set complete with: handle, sleeve, rosette and installation unit  
 suitable for rough part no. 59970 (Flexx Boxx)  
 (Flexx Boxx to be ordered separately)

**51173**  
**Thermostat battery**  
 concealed fitting  
 with ceramic cut-off valve,  
 safety cut-off at 38 °C,  
 set complete with: handle, sleeve, diverter, rosette and installation unit  
 suitable for rough part no. 59970 (Flexx Boxx)  
 (Flexx Boxx to be ordered separately)

**51172**  
**Single lever bath tub and shower mixer**  
 concealed fitting  
 with/without safety device  
 set complete with: handle, sleeve, diverter, rosette and installation unit  
 suitable for rough part no. 59970 (Flexx Boxx)  
 (Flexx Boxx to be ordered separately)

**51174**  
**Thermostat battery**  
 concealed fitting  
 with ceramic cut-off and switch valve,  
 safety cut-off at 38 °C,  
 set complete with: handle, sleeve, diverter, rosette and installation unit  
 suitable for rough part no. 59970 (Flexx Boxx)  
 (Flexx Boxx to be ordered separately)

**51185**  
**Hand shower sliding rail**  
 consisting of:  
 – wall rail 900, 1200 mm  
 – sliding bracket for hand shower  
 – height adjustment via handle,  
 tilting angle adjustable  
 – spacer disc (5 mm)

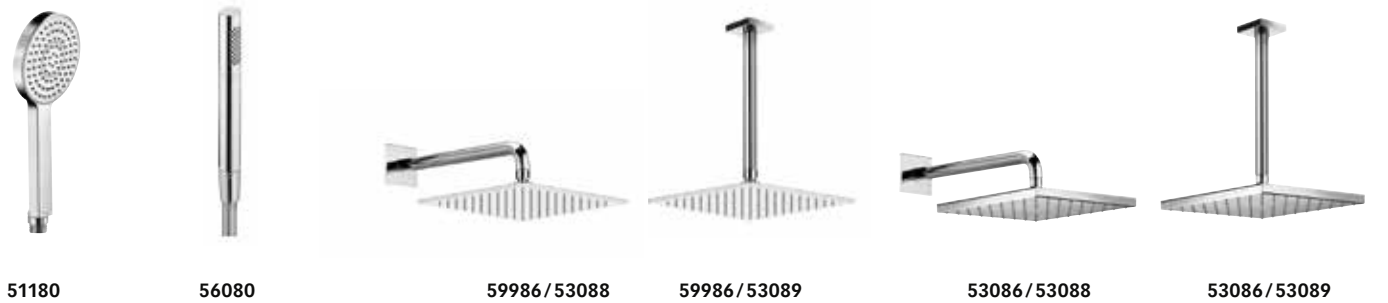

51180 56080 59986/53088 59986/53089 53086/53088 53086/53089



51147 51191 51192 54941 54995

**51180**  
**Hand shower**  
with anti limescale device  
with normal jet  
restricted flow rate 12 l/min.

**56080**  
**Round pencil hand shower**  
with normal jet

**51147**  
**Wall outlet for shower hose DN 15**  
suitable for all concealed fittings  
with backflow preventer

**51191**  
**Wall bracket for hand shower**  
for shower hoses with conical nuts  
usable on left or right

**59986/53088**  
**Shower head with wall outlet DN 15**  
with shower head rail,  
restricted flow rate 15 l/min.  
Projection: 300, 450 mm  
200 x 200 mm  
250 x 250 mm  
300 x 300 mm  
Only available in chrome finish

**59986/53089**  
**Shower head with ceiling outlet DN 15**  
with shower head rail,  
restricted flow rate 15 l/min.  
Projection: 100, 300 mm  
200 x 200 mm  
250 x 250 mm  
300 x 300 mm  
Only available in chrome finish

**51192**  
**Wall outlet for hand shower DN 15**  
with integrated wall outlet  
for shower hoses with conical nuts  
suitable for all concealed fittings  
with backflow preventer

**53086/53088**  
**Shower head with wall outlet DN 15**  
with shower head rail,  
restricted flow rate 15 l/min.  
Projection: 300, 450 mm

**53086/53089**  
**Shower head with ceiling outlet DN 15**  
with shower head rail,  
restricted flow rate 15 l/min.  
Projection: 100, 300 mm

**54941**  
**Exposed part for angle valve DN 15/DN 20**  
complete with: handle, sleeve, rosette  
and adjustable extension  
(Angle valve DN 15/DN 20 to be ordered separately)

**54995**  
**Shower hose DN 15**  
both ends fitted with conical nut  
and twist-protection  
1250, 1600, 2000 mm



11101



11107

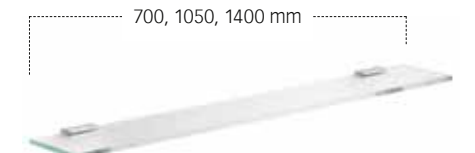

11110



11114



11115



11116



11121



11118/11119



11120/11122



11170



11172

**11101**  
**Towel rail**  
600, 800, 1000 mm

**11114**  
**Towel hook**  
47 mm

**11115**  
**Towel hook**  
double, 46 mm

**11118/11119**  
**Towel holder**  
2-arms, fixed  
Projection: 340, 450 mm

**11107**  
**Grab bar/Towel rail (USA)**  
300 mm

**11116**  
**Robe hook**  
67 mm

**11120/11122**  
**Towel holder**  
1-arm, fixed  
Projection: 340, 450 mm

**11110**  
**Shelf**  
with crystalline glass shelf  
Dimensions (w x h):  
700 x 120 mm  
1050 x 120 mm  
1400 x 120 mm

**11121**  
**Towel ring**

**11170**  
**Towel holder**  
holds 6 guest towels  
(approx. 30 x 50 cm)

**11172**  
**Guest towel basket**  
removable,  
MDF white lacquered  
Dimensions (w x h x d): 200 x 350 x 200 mm





11158



11159



11162

11163



11164



11150



11151



11152



11153



11155

**11158**  
**Shower basket**  
aluminium silver-anodized/chrome-plated  
Dimensions (w x h x d): 300 x 95 x 67 mm

**11164**  
**Toilet brush set**  
with crystal glass insert, matt,  
brush with handle and spare brush head

**11152**  
**Lotion dispenser**  
complete with crystal glass, matt  
Capacity: approx. 180 ml

**11159**  
**Shower basket**  
aluminium silver-anodized/chrome-plated  
with integrated glass scraper  
Dimensions (w x h x d): 300 x 95 x 67 mm

**11150**  
**Tumbler holder**  
complete with crystal glass tumbler, hand-  
blown

**11153**  
**Double holder**  
consisting of:  
– 1 x crystal glass matt, hand-blown  
– 1 x lotion dispenser (crystal glass, matt)  
complete with pump for liquid soap  
Capacity: approx. 180 ml

**11162**  
**Toilet paper holder**  
open form,  
for 120 mm wide paper rolls

**11163**  
**Spare paper holder**

**11151**  
**Double tumbler holder**  
complete with crystal glasses, hand-blown

**11155**  
**Soap holder**  
complete with removable crystal glass dish

Surfaces:

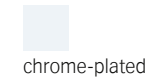

chrome-plated

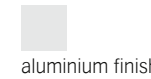

aluminium finish



stainless steel finish



52902



52904



52916



52902



52902



59916

**52902**  
**Single lever basin mixer 150**  
without rosette,  
suitable with Varicor® washbasin article no. 32960,  
without pop-up waste, 1-hole installation,  
cartridge mixer with ceramic sealing gaskets,  
aerator cache XT PCA M 24x1,  
flow rate limited to 7.6 l/min.

**52904**  
**Single lever basin mixer 100**  
with/without pop-up waste 1 1/4 inch,  
1-hole installation,  
cartridge mixer with ceramic sealing gaskets,  
aerator cache XT PCA M 24x1,  
flow rate limited to 7.6 l/min.

**52902**  
**Single lever basin mixer 150**  
with/without pop-up waste 1 1/4 inch,  
1-hole installation,  
cartridge mixer with ceramic sealing gaskets,  
aerator cache XT PCA M 24x1,  
flow rate limited to 7.6 l/min.

**52916**  
**Single lever basin mixer**  
concealed fitting DN 15,  
cartridge mixer with ceramic sealing gaskets,  
aerator cache XT PCA M 24x1,  
flow rate limited to 7.6 l/min.  
(essential for installation:  
rough part article no. 59916 to be ordered separately)  
Projection: 152, 198 mm

**59916**  
**Installation unit for single lever basin mixer**  
rough part for recessed installation  
Installation depth: 70-100 mm



52945



52908



52920



52991



52909



52924



53947

**52908****Pillar tap 100**

without pop-up waste,  
1-hole installation, lever head action 90° right,  
with ceramic sealing gaskets,  
aerator cache XT PCA M 24x1,  
flow rate limited to 7.6 l/min.

**52909****Single lever bidet mixer**

with pop-up waste 1 1/4 inch,  
1-hole installation,  
cartridge mixer with ceramic sealing gaskets,  
ball-joint, aerator cache XT PCA M 24x1,  
flow rate limited to 7.6 l/min.

**52945****Bath spout DN20**

suitable for all concealed fittings  
Projection: 141 mm

**52920****Bath tub mixer DN15**

exposed fitting,  
cartridge mixer with ceramic sealing gaskets,  
ceramic stop valve and diverter,  
with backflow preventer,  
wall outlet for shower hose DN 15,  
flow rate limited to 15 l/min.

**52924****Shower mixer DN15**

exposed fitting,  
ceramic stop valve,  
cartridge mixer with ceramic sealing gaskets,  
with backflow preventer,  
wall outlet for shower hose DN 15,  
flow rate limited to 15 l/min.

**52991****Hand shower bracket**

for shower hoses with conical nuts

**53947****Wall outlet for shower hose DN15**

suitable for all concealed fittings

Surface:

  
chrome-plated

53902

**WELL**  
Water Efficiency Label

53902

**WELL**  
Water Efficiency Label

53902

**WELL**  
Water Efficiency Label

53905

**WELL**  
Water Efficiency Label  
applied

53908

**53902****Single lever basin mixer 90**

with/without pop-up waste 1 1/4 Inch,  
1-hole installation, cartridge mixer  
with ceramic sealing gaskets  
and temperature limiter,  
aerator M 24 x 1  
adjustable flow angle +/- 8° limiter,  
restricted flow rate 6 l/min.  
Height: 161 mm  
Projection: 107 mm

**53902****Single lever basin mixer 130**

with/without pop-up waste 1 1/4 Inch,  
1-hole installation, cartridge mixer  
with ceramic sealing gaskets  
and temperature limiter,  
aerator M 24 x 1  
adjustable flow angle +/- 8° limiter,  
restricted flow rate 6 l/min.  
Height: 204 mm  
Projection: 125 mm

**53905****Single lever basin mixer 200**

with/without pop-up waste 1 1/4 Inch,  
spout swivelling +/- 60°,  
1-hole installation, cartridge mixer  
with ceramic sealing gaskets,  
aerator M 24 x 1 cache  
restricted flow rate 6 l/min.

**53902****Single lever basin mixer 210**

without pop-up waste,  
1-hole installation, cartridge mixer  
with ceramic sealing gaskets  
and temperature limiter,  
aerator M 24 x 1  
adjustable flow angle +/- 8° limiter,  
restricted flow rate 6 l/min.  
Height: 289 mm  
Projection: 140 mm

**53908****Pillar tap 200**

without pop-up waste,  
spout swivelling +/- 60°,  
1-hole installation, lever head action 90°  
with ceramic sealing gaskets,  
aerator M 24 x 1 cache



53909



54908



53945



53920



53924



53971



53972

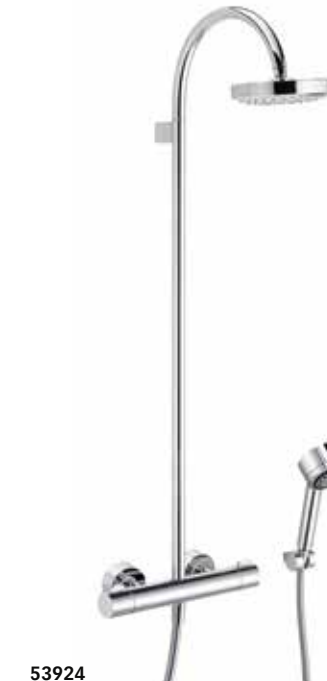

53924



54985

54987

**53909**  
**Single lever bidet mixer**  
 with pop-up waste 1 1/4 Inch,  
 1-hole installation, cartridge mixer  
 with ceramic sealing gaskets  
 and temperature limiter,  
 aerator M 24 x 1  
 restricted flow rate 6 l/min.

**53945**  
**Bath filler/spout DN20**  
 suitable for all concealed fittings  
 Projection: 138, 188 mm

**54908**  
**Pillar tap 50**  
 without pop-up waste,  
 1-hole installation, lever head action 90°  
 with ceramic sealing gaskets  
 aerator M 18 x 1

**53920**  
**Bath tub mixer DN15**  
 exposed fitting  
 cartridge mixer with ceramic sealing gaskets,  
 ceramic stop valve and diverter,  
 with backflow preventer  
 wall outlet for shower hose DN15,  
 restricted flow rate 12 l/min.

**53924**  
**Shower mixer DN15**  
 exposed fitting  
 ceramic stop valve,  
 cartridge mixer with ceramic sealing gaskets,  
 with backflow preventer  
 wall outlet for shower hose DN15,  
 restricted flowrate 12 l/min.

**53971**  
**Single lever shower mixer**  
 concealed fitting  
 set complete with: handle, sleeve, rosette  
 and installation unit  
 suitable for rough part no. 59970 (Flexx Boxx)  
 (Flexx Boxx to be ordered separately)

**53972**  
**Single lever bath tub and shower mixer**  
 concealed fitting  
 with/without safety device  
 set complete with: handle, sleeve, diverter,  
 rosette and installation unit  
 suitable for rough part no. 59970 (Flexx Boxx)  
 (Flexx Boxx to be ordered separately)

**53924**  
**Shower mixer with head shower**  
 exposed fitting  
 ceramic stop valve and diverter,  
 cartridge mixer with ceramic sealing gaskets,  
 with backflow preventer  
 head shower swivelling, Ø 180 mm,  
 restricted flowrate 9 l/min.,  
 hand shower with normal-, soft- and massage jet,  
 with sliding bracket, wall bracket  
 and shower hose, 1600 mm

**54985**  
**Hand shower sliding rail**  
 consisting of:  
 – wall rail, 800 mm  
 – sliding bracket for shower head  
 – height adjustment via handle,  
 tilting angle adjustable  
 – spacer disc (5 mm)

**54987**  
**Hand shower sliding rail set**  
 consisting of:  
 – rail with sliding bracket, 800 mm  
 – height adjustment via handle,  
 tilting angle adjustable  
 – spacer disc (5 mm)  
 – hand shower with normal jet and massage jet  
 – shower hose, 1600 mm



51686/51688

51686/51689

54941

54995

53980

54991

53947



59991

**51686/51688**  
**Overhead shower with wall outlet DN 15**  
 Ø 180 mm, with shower head rail,  
 restricted flow rate 15 l/min.  
 Projection: 300, 450 mm

**51686/51689**  
**Head shower with ceiling outlet DN 15**  
 Ø 180 mm, with shower head rail,  
 restricted flow rate 15 l/min.  
 Projection: 100, 300 mm

**53980**  
**Hand shower**  
 with anti limescale device  
 Functions:  
 – normal jet  
 – soft jet  
 – massage jet

**59991**  
**Wall bracket for hand shower**  
 for shower hoses with conical nuts,  
 with adjustable tilt angle 20-65°  
 Projection: 97 mm

**54941**  
**Exposed part for angle valve DN 15/DN 20**  
 complete with: handle, sleeve, rosette  
 and adjustable extension  
 (Angle valve DN 15/DN 20 to be  
 ordered separately)

**54991**  
**Wall bracket for hand shower**  
 for shower hoses with conical nuts

**54995**  
**Shower hose DN 15**  
 both ends fitted with conical nut  
 and twist-protection  
 1250, 1600, 2000 mm

**53947**  
**Wall outlet for shower hose DN 15**  
 suitable for all concealed fittings

Surfaces:

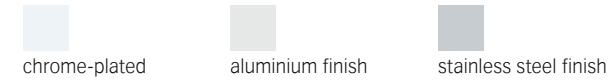

14901

14907

14910

14911/14914/14916

14913

14918/14919

14921

14922

14955

**14901**  
**Towel rail**  
 600, 800 mm

**14907**  
**Grab bar/Towel rail (USA)**  
 300 mm

**14910**  
**Shelf**  
 with crystalline plate, underside matt  
 Dimensions (w x h):  
 220 x 100 mm  
 350 x 120 mm  
 550 x 120 mm

**14911**  
**Towel hook**  
 with door buffer, black

**14913**  
**Towel hook panel**  
 with 4 hooks

**14918/14919**  
**Towel holder**  
 2-arms, swivelling  
 Projection: 300, 438 mm

**14914/14916**  
**Towel hook**

**14922**  
**Towel ring**  
 small model

**14955**  
**Soap holder**  
 complete with crystal glass dish

**14921**  
**Towel ring**  
 large model



14958



14950



14953



14952



14953



14957

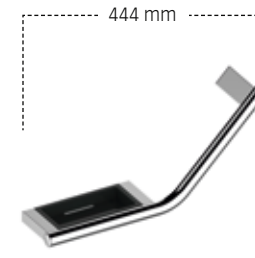

14909



14920



14951



14949



11649



14954



14909



14923



14975

**14958**  
**Universal shelf**  
with crystal glass plate  
Surface chrome-plated, stainless steel or  
aluminium silver-anodized (E6 EV1)/chrome-plated  
Dimensions (w x h): 210 x 115 mm

**14952**  
**Lotion dispenser standing model**  
Capacity: approx. 250 ml

**14949**  
**Built in soap dispenser**  
for mounting on washbasin or washbasin worktop  
Capacity: approx. 500 ml

**14950**  
**Tumbler holder**  
complete with crystal glass tumbler

**14953**  
**Lotion dispenser wall model**  
Capacity: approx. 250 ml

**11649**  
**Soap dispenser**  
for mounting on washbasin or washbasin worktop,  
including foam soap (2 x 500 ml),  
also available for liquid soap  
Capacity: approx. 500 ml  
Height: 93 mm

**14953**  
**Lotion dispenser**  
complete with crystal glass, matt  
Capacity: approx. 250 ml

**14957**  
**Foam soap dispenser**  
opal glass, matt  
including foam soap (2 x 250 ml)  
Capacity: approx. 250 ml

**14954**  
**Lotion dispenser**  
Capacity: approx. 1,1 l

**14909**  
**Grab bar 135°**  
with soap holder,  
right version /left version,  
soap holder optionally in dark grey (RAL 7021),  
light grey (RAL 7035) or white (RAL 9010)

**14920**  
**Towel holder**  
1-arm, fixed  
Projection: 450 mm

**14923**  
**Towel holder**  
1-arm, fixed  
Projection: 340 mm

**14951**  
**Lotion dispenser**  
complete with holder and pump,  
for liquid soap  
Capacity: approx. 280 ml  
Dosage: approx. 0.5 ml/stroke

**14975**  
**Towel rack**  
shelf made of ESG glass  
Width: 600 mm



14958



14963



14959



14967



04989



14960



04976



14972

14964



14961



14963



14966-14971



14962



14969



14977

04988

14958

**Shower basket**

two parts: metal bracket and detachable synthetic insert (soap resistant, unbreakable, UV-protected)

14959

**Shower basket with integrated glass scraper**

three parts: metal bracket, detachable synthetic insert (soap resistant, unbreakable, UV-protected) and integrated glass scraper

Plastic insert and glass scraper optionally in dark grey (RAL 7021), light grey (RAL 7035) or white (RAL 9010)

14963

**Toilet paper double holder**

for 100/120 mm wide paper rolls

14967

**Moisture box**

with cover and housing made of metal, with detachable synthetic insert box (light grey) for maximum packing size 145 x 102 x 43 mm

04989

**Waste bin**

complete with insert (dark grey) and plastic lid  
Capacity: 5 l

Surface casing/handle:  
chrome finish (polished stainless steel)  
stainless steel  
aluminium lacquered  
white lacquered (RAL 9010)

Surface lid:  
dark grey (RAL 7021)  
white (RAL 9010)

14960

**Toilet paper holder**

with cover,  
for 100/120 mm wide paper rolls

04976

**Hygiene bag dispenser**

ABS plastic for max. 25 bags,  
including first 25 bags

14972/14964

**Toilet brush set**

with removable plastic insert,  
brush and spare brush head

14961

**Toilet paper holder**

theft-proof,  
for 100/120 mm wide paper rolls

14963

**Spare paper holder**

14966

**Doorplate**

Symbol Ladies

14967

**Doorplate**

Symbol Gents

14968

**Doorplate**

Symbol Disabled

14971

**Doorplate**

Symbol Ladies/Gents

14962

**Toilet paper holder**

open form,  
for 100/120 mm wide paper rolls

14969

**Multiple toilet roll dispenser**

for horizontal or vertical installation,  
can be mounted for 2 rolls of 100/120 mm in width

14977

**Sanitary waste bin**

wall mounted  
Capacity: 3 l

04988

**Waste bin**

with detachable black insert  
Capacity: 5 l



04979



14982



14985



14988



14995



17649



06549



14980



14983



14930 / 14932



14927



14934



14935



14924 / 14925



14936 / 14937



14939



14931 / 14941



14938



14940

04979

**Clothes line**

complete with wall mounting element  
extendable up to max. 2.80 m

14985

**Paper towel dispenser**

14988

**Waste bin**

wall mounted  
Capacity: 30 l

17649

**Cosmetic mirror**

non illuminated, with pivoting arm,  
adjustable in three dimensions,  
magnification factor x 2.5, Ø 190 mm

14982

**Bathroom stool**

also suitable for wet rooms  
seat white, dark grey or light grey  
Surface chrome-plated  
or aluminium silver-anodized (E6 EV1)

14995

**Hair dryer**

with wall mounting element, 230 V  
Features:  
– On-off switch with indicator light  
on the wall holder  
– 3 heating levels up to max. 1800 W  
– 2 speed levels  
– Cold air button  
– Overheating protection

06549

**Wall light**

complete with opal glass, matt  
and bulbs 2 x 40 W E14

14980

**Tip-up seat**

for wall mounting  
tip-up seat  
seat size: 360 mm wide  
white, dark grey or light grey  
Surface chrome-plated  
or aluminium silver-anodized (E6 EV1)

14983

**Tip-up seat**

for wall mounting  
tip-up seat  
seat size: 370 mm wide  
white, dark grey or light grey  
Surface chrome-plated or aluminium laquered

14930

**Shower curtain rail**

300–2000 mm

14932

**Connecting tube**

14924

**Tube angle piece 90°**

for square shower tray

14925

**Tube angle piece 90°**

for quarter-circle shower tray

14931

**Connecting piece**

in dark grey or chrome-plated

14941

**Ceiling support (set)**

complete, consisting of:  
– 1 x wall mounting set  
– 1 x shower curtain rail  
– 1 x connecting piece, 300–800 mm

14927

**Curtain ring**

in black or white

14936 / 14937

**Set of shower curtain rails**

for square shower tray 800 x 800 mm/900 x 900 mm  
consisting of:  
– 3 x wall mounting set  
– 2 x shower curtain rail, 700 mm/800 mm  
– 1 x tube angle piece 90° for square shower tray  
– 1 x ceiling support, 400 mm  
– 1 x connecting piece  
– 2 x 10 shower curtain rings, white

14938

**Set of shower curtain rails**

for quarter-circle shower tray 900 x 900 mm  
consisting of:  
– 3 x wall mounting set  
– 2 x shower curtain rail, 300 mm  
– 1 x tube angle piece 90°  
for quarter-circle shower tray  
– 1 x ceiling support, 400 mm  
– 1 x connecting piece  
– 2 x 10 shower curtain rings, white

14934

**Wall mounting set**

with cover, for slanted ceilings  
adjustable between 10 to 80 degrees

14935

**Wall mounting set**

with decor cover

14939

**Set of shower curtain rails**

for square shower tray 1000 x 1000 mm/1200 x 1200 mm  
consisting of:  
– 2 x wall mounting set  
– 2 x shower curtain rail, 900 mm/1100 mm  
– 1 x tube angle piece 90° for square shower tray  
– 1 x ceiling support, 400 mm  
– 2 x 10 shower curtain rings, white

14940

**Set of shower curtain rails**

for square shower tray 1000 x 1000 mm/1200 x 1200 mm  
consisting of:  
– 2 x wall mounting set  
– 2 x shower curtain rail, 900 mm/1100 mm  
– 1 x shower curtain rail, 800 mm/1000 mm  
– 2 x tube angle piece 90° for square shower tray  
– 2 x ceiling support, 400 mm  
– 3 x 10 shower curtain rings, white

Colour variations shower curtain

- white  
PLAN uni and PLAN maxx
  
- light grey  
PLAN uni
  
- Ecrú  
PLAN uni
  
- truffe  
PLAN uni
  
- anthracite  
PLAN uni
  
- black  
PLAN uni
  
- off-white  
PLAN Flame CS



14945 / 14943 / 14944 / 14946 / 14947 / 34948

**14943 / 14944**  
**Shower curtain PLAN uni\***  
 100% Trevira, 80 g/m<sup>2</sup>, shower-proof, fungicidal, anti-bacterial, anti-static, washable at 30°C, can be disinfected at 60°C (shrinkage rate 1-2%), ironing possible (shrinkage 1-3%), tested for harmful substances according to OEKO-Tex Standard 100  
 Colours: white, ecru, light grey, truffe, anthracite, black  
 Full length: 1800, 2000 mm  
 Width: 1400, 2000, 3000 mm

**14943 / 14944**  
**Shower curtain PLAN Flame CS\***  
 highly flame resistant according to DIN 4102/B1 100% Trevira, 80 g/m<sup>2</sup>, shower-proof, fungicidal, anti-bacterial, anti-static, washable at 30°C, can be disinfected at 60°C (shrinkage rate 1-2%), ironing possible (shrinkage 1-3%), tested for harmful substances according to OEKO-Tex Standard 100  
 Colour: off-white  
 Full length: 1800, 2000 mm  
 Width: 1400, 2000, 3000 mm

**14946 / 14947 / 34948**  
**Shower curtain PLAN maxx\***  
 100% polyester, 75 g/m<sup>2</sup>, shower-proof, fungicidal, anti-bacterial, washable at 30°C (Shrinkage rate 3%), ironing possible (shrinkage 1-3%), tested for harmful substances according to OEKO-Tex Standard 100  
 Colour: white  
 Full length: 670, 1800, 2000 mm  
 Width: 1400, 1800, 2000, 3000 mm

**14945**  
**Shower curtain PLAN\***  
 all sizes are custom made.  
 Please specify: material, colour, full length and width

**\*Notes on production characteristics:**  
 Vertical seams, reinforced stainless steel eyelets, distance between the eyelets approx. 20 cm, roll hem stainless steel weighted, 50 g per metre, complete with curtain rings, white.

**Notes on sizes:** The sizes indicated are the sizes of the finished curtain. To prevent the curtain from touching the ground we recommend a distance from curtain to floor of approx. 30 mm. Distance between the middle of the curtain rod and the upper edge of the curtain approx. 40 mm. The width of the curtain should be approx. 1.3 to 1.5 times the length of the shower curtain rod.

Surfaces:

- chrome-plated
- aluminium silver-anodized (E6 EV1) or aluminium finish



34940



34910



34912



34901



34907

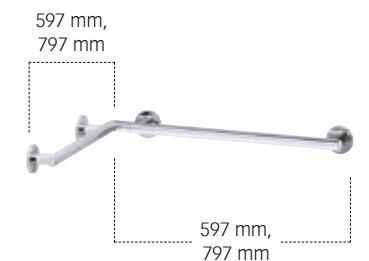

34911

**34940**  
**Spray guard**  
 to be hooked on rail system or grab rails complete with shower curtain PLAN maxx (670 x 800 mm)

**34910**  
**Hand shower bracket**  
 for shower rail, height adjustable

**34912**  
**Hand shower sliding rail**  
 complete with shower bracket  
 900, 1100 mm

**34901**  
**Grab bar/Towel rail (USA)**  
 for horizontal or vertical installation  
 300, 400, 500, 600, 700, 800, 900, 1000, 1100 mm

**34907**  
**Angle bar 135°**  
 may be used on the left or right  
 300, 400 mm

**34911**  
**Corner rail for shower/bath**  
 usable on left or right  
 Dimensions (w x h):  
 400 x 400 mm  
 400 x 600 mm  
 600 x 600 mm





34906



34906

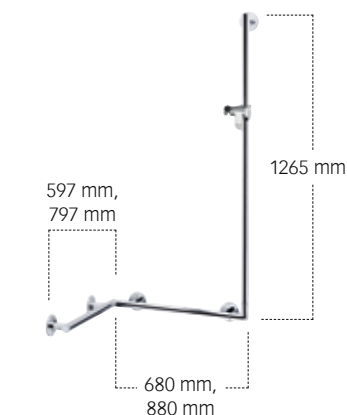

34908



34914

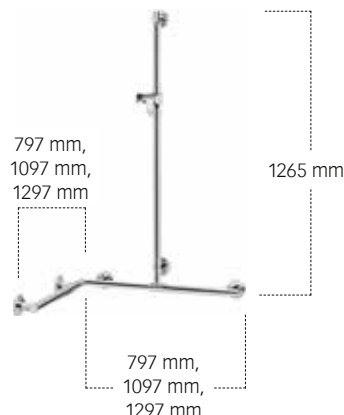

34915



Surfaces:

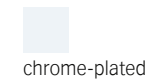

chrome-plated



aluminium silver-anodized (E6 EV1) or aluminium finish

Colour variations



dark grey



light grey



white



34981



34979



34983

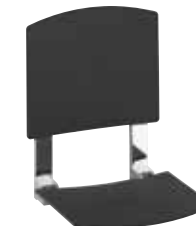

34982



**34906**  
**Angle bar 90°**  
complete with shower bracket  
usable as shower rail on left or right  
Dimensions (w x h): 400 x 1100 mm

**34908**  
**Rail system**  
complete with shower bracket  
usable on left or right  
Dimensions (w x h x d):  
400 x 400 x 1100 mm  
400 x 600 x 1100 mm  
600 x 400 x 1100 mm  
600 x 600 x 1100 mm

**34906**  
**Angle bar 90°**  
usable on left or right  
Dimensions (w x h): 300 x 600 mm

**34914**  
**Rail system**  
complete with shower bracket  
shower rail flexible positioning of sliding rail  
prior to final installation  
Dimensions (w x h x d):  
600 x 600 x 1100 mm  
600 x 900 x 1100 mm  
900 x 600 x 1100 mm  
900 x 900 x 1100 mm  
900 x 1100 x 1100 mm  
1100 x 900 x 1100 mm

**34915**  
**Rail system**  
complete with shower bracket  
shower rail flexible positioning of sliding rail  
prior to final installation  
Dimensions (w x h x d):  
600 x 600 x 1100 mm  
600 x 900 x 1100 mm  
900 x 600 x 1100 mm  
900 x 900 x 1100 mm  
900 x 1100 x 1100 mm  
1100 x 900 x 1100 mm

**34979**  
**Back rest**  
for use on WC,  
consists of wall rail (600 mm)  
and back rest

**34983**  
**Tip-up seat**  
for wall mounting  
tip-up seat,  
seat size 450 mm wide

Surface chrome-plated or aluminium lacquered

**34981**  
**Tip-up seat with back rest**  
for hanging in handles as well as shower  
and bath tub handles, tip-up seat,  
seat size 360 mm wide

**34982**  
**Tip-up seat with back rest**  
for wall mounting  
tip-up seat,  
seat size 360 mm wide

Colour variations pivoted supporting rail



34902



34903



34902



34904



34905



34962



34964

**34902**  
**Pivoted supporting rail for wash basin**  
lifts up,  
braked version,  
with synthetic covered support  
Projection: 650 mm

**34904**  
**Supporting rail for wash basin**  
fixed,  
with synthetic covered support  
Projection: 450/650 mm

**34903**  
**Pivoted supporting rail for WC\***  
lifts up,  
braked version,  
with synthetic covered support,  
removable toilet paper holder with rollbrake  
Projection: 700/850 mm

**34905**  
**Supporting rail for WC\***  
fixed,  
with synthetic covered support,  
removable toilet paper holder with rollbrake  
Projection: 700/850 mm

**34902**  
**Cover plate**  
for fastening holes for supporting rails  
and pivoted supporting rails

**34962**  
**Toilet paper holder**  
for mounting on an angle bar

**34964**  
**Toilet brush set**  
complete with synthetic insert,  
brush with extended handle and  
spare brush head

PLAN INTEGRAL

Surfaces:

 chrome-plated /  
aluminium lacquered  
(RAL 9006)

 chrome-plated /  
white lacquered  
(RAL 9010)

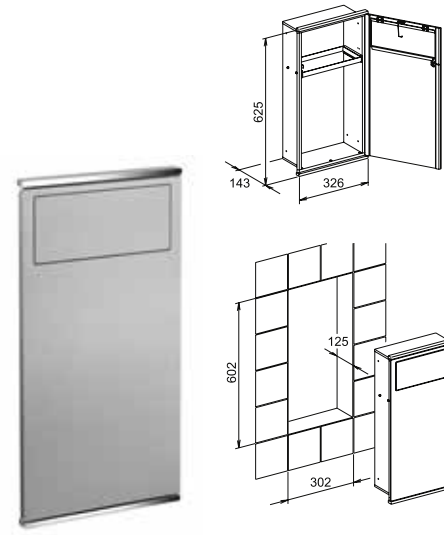

44988

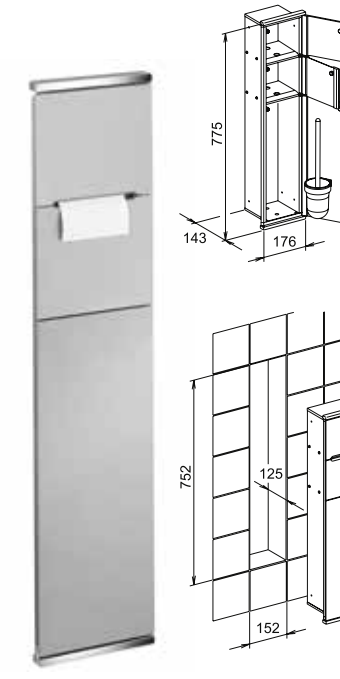

44964

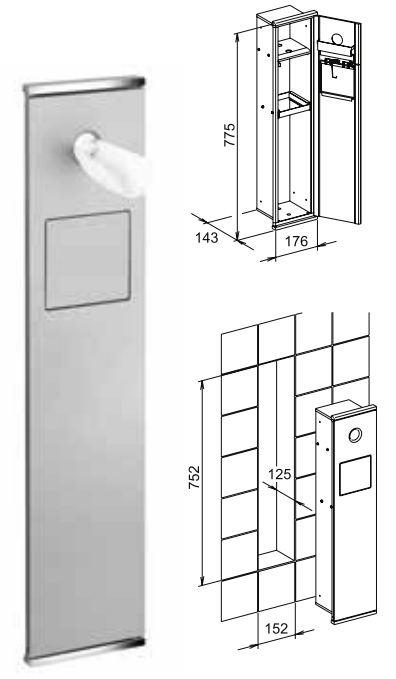

44976

**44988**  
**Module Washstand 1**  
consisting of:  
– Waste bin

**44964**  
**Module WC 1**  
consisting of:  
– Toilet brush holder  
– Toilet roll holder  
– Spare toilet roll compartment

**44976**  
**Module WC 2**  
consisting of:  
– Sanitary bag dispenser  
(including the first pack of hygiene bags)  
– Sanitary waste bin

\*also with integrated WC flushing mechanism (right/left) for Geberit, Grohe, Sanit, Tece and Viega

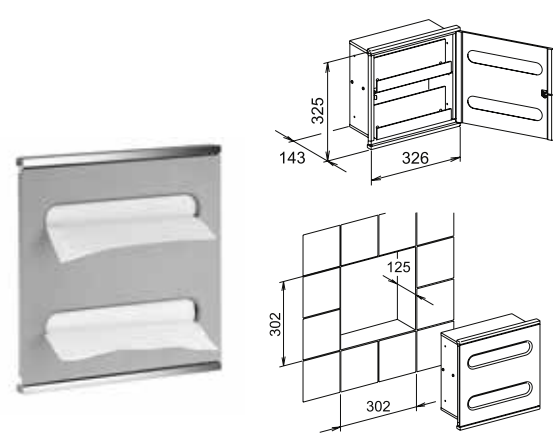

44985

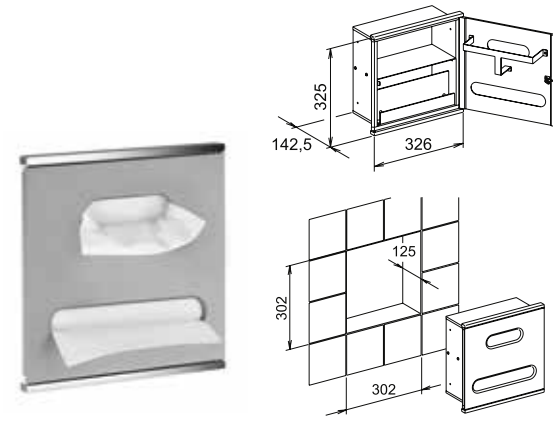

44977

**44985**  
**Module Washstand 2**  
 consisting of:  
 – 2 Paper towel dispensers  
 (each for max. 100 paper towels)

**44977**  
**Module Washstand 3**  
 consisting of:  
 – Tissue box (for max. 150 tissues)  
 – Paper towel dispenser  
 (for max. 100 paper towels)

ELEGANCE

Surface:  
  
 chrome-plated



51602



51604



51608

**51602**  
**Single lever basin mixer 120**  
 with/without pop-up waste 1 1/4 Inch,  
 1-hole installation, cartridge mixer  
 with ceramic sealing gaskets  
 aerotor M 24 x 1  
 Flow rate limited to 7,6 l/min.

**51604**  
**Single lever basin mixer 90**  
 with/without pop-up waste 1 1/4 Inch,  
 1-hole installation, cartridge mixer  
 with ceramic sealing gaskets  
 aerotor M 24 x 1  
 Flow rate limited to 7,6 l/min.

**51608**  
**Pillar tap 90**  
 without pop-up waste,  
 1-hole installation, lever head action 90°  
 with ceramic sealing gaskets



SENSOR

51611



51601

**51611**  
**Infrared basin mixer 120**  
 with/without pop-up waste 1 1/4 Inch,  
 1-hole installation, infrared sensor,  
 manual water-stop for cleaning,  
 with temperature control,  
 aerotor M 24 x 1  
 either battery or mains operated

**51601**  
**Extension to single lever basin mixer**  
 matches single lever basin mixers 51602 and 51604,  
 pillar tap 51608 and infrared basin mixers 51611  
 and 51613

**Please note:** Single lever basin mixer to be  
 ordered separately!



SENSOR

51613



51616

**51613**  
**Infrared basin mixer 120**  
 without pop-up waste,  
 1-hole installation, infrared sensor,  
 manual water-stop for cleaning,  
 without temperature control,  
 aerotor M 24 x 1  
 either battery or mains operated

**51616**  
**Single lever basin mixer**  
 concealed fitting DN 15  
 cartridge mixer with ceramic sealing gaskets  
 and temperature control,  
 aerator SLIM SSR M 24 x 1,  
 adjustable flow angle  
 (essential for installation: rough part  
 article no. 51116 to be ordered separately)

**Note:**  
 flexible arrangement of lever and spout possible  
 during assembly.



51620

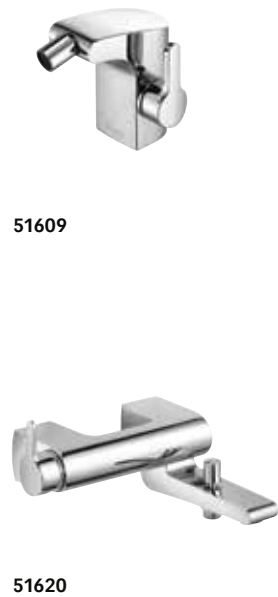

51609

51620



51645

51630



51624



51624

51626



51626

**51620**  
**Single lever bath tub mixer with head shower**  
 exposed fitting  
 cartridge mixer with ceramic sealing gaskets,  
 with automatic diverter, with backflow preventer,  
 head shower swivelling, Ø 180 mm,  
 hand shower with normal, soft and massage jet,  
 with sliding bracket, wall bracket  
 and shower hose, 1600 mm

**51609**  
**Single lever bidet mixer**  
 with pop-up waste 1 1/4 Inch,  
 1-hole installation, cartridge mixer  
 with ceramic sealing gaskets  
 aerotor M 24 x 1

**51620**  
**Single lever bath tub mixer**  
 exposed fitting  
 cartridge mixer with ceramic sealing gaskets,  
 with automatic diverter and backflow preventer

**51645**  
**Bath filler/spout DN20**  
 suitable for all concealed fittings  
 Projection: 173, 223 mm

**51630**  
**Single lever bath tub and shower mixer**  
 4-hole bath deck-mounted  
 cartridge mixer with ceramic sealing gaskets,  
 with automatic diverter and backflow preventer  
 concealable hand shower with normal, soft  
 and massage jet

**51624**  
**Single lever bath shower mixer**  
**with head shower**  
 exposed fitting  
 cartridge mixer with ceramic sealing gaskets,  
 diverter head shower/hand shower with ceramic  
 sealing gaskets, with backflow preventer,  
 head shower swivelling, Ø 180 mm,  
 hand shower with normal-, soft- and massage jet,  
 with sliding bracket, wall bracket  
 and shower hose, 1600 mm

**51624**  
**Single lever shower mixer DN15**  
 exposed fitting  
 cartridge mixer with ceramic sealing gaskets,  
 with backflow preventer

**51626**  
**Thermostat battery for shower**  
 exposed fitting  
 handle with 50% water consumption regulation,  
 safety cut-off at 38°C,  
 with backflow preventer

**51626**  
**Thermostat battery with head shower**  
 exposed fitting  
 safety cut-off at 38°C,  
 diverter head shower/hand shower  
 with ceramic sealing gaskets,  
 with backflow preventer  
 head shower swivelling, Ø 180 mm,  
 hand shower with normal-, soft- and massage jet,  
 with sliding bracket, wall bracket  
 and shower hose, 1600 mm



51671



51672



51686/51689



51686/51688



51673



51674



51680



54995

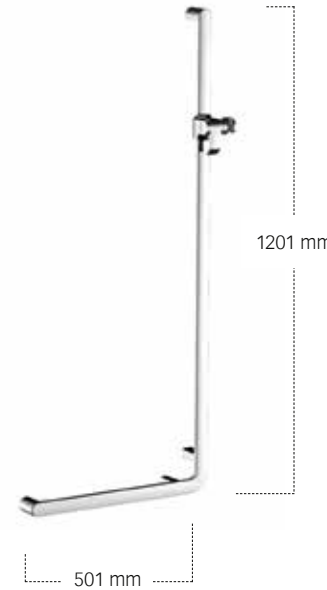

31606



31614



51685

51687



59991



54991



54941



54947

**51671**  
**Single lever shower mixer**  
concealed fitting  
set complete with: handle, sleeve, rosette and installation unit  
suitable for rough part no. 59970 (Flexx Boxx)  
(Flexx Boxx to be ordered separately)

**51673/51674**  
**Thermostat battery**  
concealed fitting  
with ceramic cut-off valve (51673),  
with ceramic cut-off and switch valve (51674),  
safety cut-off at 38°C,  
set complete with: handle, sleeve, diverter,  
rosette and installation unit  
suitable for rough part no. 59970 (Flexx Boxx)  
(Flexx Boxx to be ordered separately)

**51672**  
**Single lever bath tub and shower mixer**  
concealed fitting  
with/without safety device  
set complete with: handle, sleeve, diverter,  
rosette and installation unit  
suitable for rough part no. 59970 (Flexx Boxx)  
(Flexx Boxx to be ordered separately)

**51686/51689**  
**Head shower with ceiling outlet DN 15**  
Ø 180 mm, with shower head rail,  
restricted flow rate 15 l/min.  
Projection: 100, 300 mm

**51686/51688**  
**Overhead shower with wall outlet DN 15**  
Ø 180 mm, with shower head rail,  
restricted flow rate 15 l/min.  
Projection: 300, 450 mm

**51680**  
**Hand shower**  
with anti limescale device  
Functions:  
– normal jet  
– soft jet

**54995**  
**Shower hose DN 15**  
both ends fitted with conical nut  
and twist-protection  
1250, 1600, 2000 mm

**31606**  
**Angle bar 90°**  
for use as shower rail  
complete with shower bracket  
usable as shower rail on left or right  
Dimensions (w x h): 400 x 1100 mm

**59991**  
**Wall bracket for hand shower**  
for shower hoses with conical nuts,  
with adjustable tilt angle 20-65°  
Projection: 97 mm

**54991**  
**Wall bracket for hand shower**  
for shower hoses with conical nuts

**31614**  
**Rail system**  
complete with shower bracket  
shower rail flexible positioning of  
sliding rail prior to final installation  
Dimensions (w x h):  
600 x 1100 mm  
800 x 1100 mm  
1000 x 1100 mm

**54941**  
**Exposed part for angle valve DN 15/DN 20**  
complete with: handle, sleeve, rosette  
and adjustable extension  
(Angle valve DN 15/DN 20  
to be ordered separately)

**54947**  
**Wall outlet for shower hose DN 15**  
suitable for all concealed fittings

**51685**  
**Hand shower sliding rail**  
consisting of:  
– wall rail, 900 mm  
– sliding bracket for shower head  
– height adjustment via handle,  
tilting angle adjustable  
– spacer disc (5 mm)

**51687**  
**Hand shower sliding rail set**  
consisting of:  
– rail with sliding bracket, 900 mm  
– height adjustment via handle,  
tilting angle adjustable  
– spacer disc (5 mm)  
– hand shower with normal jet and soft jet  
– shower hose, 1600 mm



11601



31606



11618/11620



11607



11610



11621



31601



11613 / 11614



11615 / 11616



11649



11650



11654



11655



11652



11657

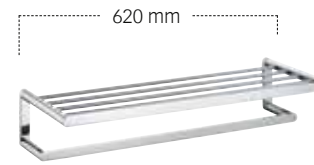

11675



11653



11658



17676

17677

**11601**  
**Towel rail**  
400, 600, 800, 1000 mm

**31606**  
**Angle bar 90°**  
optional left and right version  
Dimensions (w x h):  
300 x 600 mm  
400 x 800 mm

**11618 / 11620**  
**Towel holder**  
2-arms, swivelling  
Projection: 340, 450 mm

**11607**  
**Grab bar/Towel rail (USA)**  
300 mm

**11610**  
**Shelf**  
with crystal or crystalline glass shelf  
Dimensions (w x h x d):  
360 x 131 x 10 mm  
600 x 131 x 10 mm  
700 x 131 x 10 mm  
950 x 131 x 10 mm

**11621**  
**Towel ring**  
Projection: 95 mm

**31601**  
**Grab bar/Towel rail (USA)**  
400, 500, 600, 700, 800, 900, 1000, 1100 mm

**11613 / 11614**  
**Towel hook**  
double, 34 mm

**11615**  
**Towel hook**  
59 mm

**11616**  
**Robe hook**  
82 mm

**11649**  
**Soap dispenser**  
for mounting on washbasin or washbasin worktop,  
including foam soap (2 x 500 ml),  
also available for liquid soap  
Capacity: approx. 500 ml  
Height: 93 mm

**11650**  
**Tumbler holder/  
Tumbler holder table model**  
complete with crystal glass tumbler, matt

**11654**  
**Lotion dispenser/  
Lotion dispenser table model**  
opal glass, matt  
Capacity: approx. 220 ml

**11655**  
**Soap holder/  
Soap holder table model**  
complete with removable crystal glass dish, matt

**11652**  
**Lotion dispenser**  
complete with plastic cup, matt  
also suitable for the shower  
Capacity: approx. 180 ml

**11652**  
**Lotion dispenser**  
complete with crystal glass cup, matt  
Capacity: approx. 180 ml

**11657**  
**Sponge basket for corner installation**  
metal basket with removable insert  
in white or anthracite  
Dimensions (w x h x d): 180 x 180 x 70 mm

**11675**  
**Towel rack**  
620 mm

**11653**  
**Foam soap dispenser/  
Foam soap dispenser table model**  
opal glass, matt  
including foam soap (2 x 500 ml)  
Capacity: approx. 220 ml

**11658**  
**Sponge basket**  
metal basket with removable insert  
in white or anthracite  
Dimensions (w x h x d): 239 x 105 x 70 mm

**17676**  
**Cosmetic mirror**  
illuminated, wall model,  
optional with mains connection through wall socket  
or with spiral cord and plug,  
1 x 8 W energy efficient lamp  
magnification factor x 5, Ø 207 mm

**17677**  
**Cosmetic mirror**  
illuminated, table model,  
with power lead (1,70 m),  
1 x 8 W energy-efficient light lamp  
magnification factor x 5, Ø 207 mm

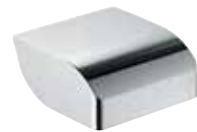

11660



11669



01680

**11660**  
**Toilet paper holder**  
with lid,  
for 100/120 mm wide paper rolls

**11669**  
**Toilet brush set**  
complete with crystal glass insert, matt,  
brush and spare brush head

**01680**  
**Tip-up seat**  
with Keucolit-seat, white



11664



11667



11682

**11664**  
**Toilet brush set**  
with lid,  
complete with synthetic insert,  
brush and spare brush head

**11667**  
**Moisture box**  
comes with porcelain box, white

**11682**  
**Bathroom stool**  
chrome-plated, walnut veneer



11662



11663



11692

**11662**  
**Toilet paper holder**  
open form,  
for 100/120 mm wide paper rolls

**11663**  
**Spare paper holder**

**11692**  
**Wall light**  
horizontal or vertical installation,  
mirrored front panel, both task lighting and  
moodlight, switched separately via room switch,  
fluorescent lamps  
Illumination/Dimensions (w x h x d):  
2 x 14 W T5/700 x 70 x 66 mm  
2 x 21 W T5/950 x 70 x 66 mm

Surface:  
chrome-plated



52702



52704



53971



53972



51645

**52702**  
**Single lever basin mixer 120**  
with/without pop-up waste 1 1/4 Inch,  
1-hole installation, cartridge mixer  
with ceramic sealing gaskets  
aerator SLIM SSR M 24 x 1,  
adjustable flow angle  
Flow rate limited to 6 l/min.

**53971**  
**Single lever shower mixer**  
concealed fitting  
set complete with: handle, sleeve, rosette  
and installation unit  
suitable for rough part no. 59970 (Flexx Boxx)  
(Flexx Boxx to be ordered separately)

**52704**  
**Single lever basin mixer 100**  
with/without pop-up waste 1 1/4 Inch,  
1-hole installation, cartridge mixer  
with ceramic sealing gaskets  
aerator SLIM SSR M 24 x 1,  
adjustable flow angle  
Flow rate limited to 6 l/min.

**53972**  
**Single lever bath tub and shower mixer**  
concealed fitting  
with/without safety device  
set complete with: handle, sleeve, diverter,  
rosette and installation unit  
suitable for rough part no. 59970 (Flexx Boxx)  
(Flexx Boxx to be ordered separately)

**51645**  
**Bath filler/spout DN20**  
suitable for all concealed fittings  
Projection: 173, 223 mm



51686/51688



51686/51689



54995

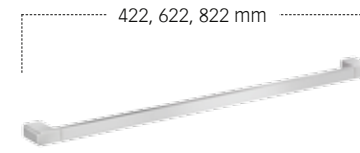

12701

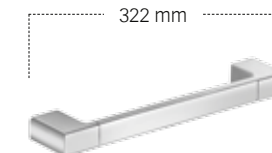

12707



52785

52787



51680



54941



12710



12713



12715



54991



59991



54947



12718/12719



12720/12722



12721

**51686/51688**  
Overhead shower with wall outlet DN 15  
Ø 180 mm, with shower head rail,  
restricted flow rate 15 l/min.  
Projection: 300, 450 mm

**51686/51689**  
Head shower with ceiling outlet DN 15  
Ø 180 mm, with shower head rail,  
restricted flow rate 15 l/min.  
Projection: 100, 300 mm

**54995**  
Shower hose DN 15  
both ends fitted with conical nut  
and twist-protection  
1250, 1600, 2000 mm

**12701**  
Towel rail  
400, 600, 800 mm

**12707**  
Grab bar/Towel rail (USA)  
300 mm

**12715**  
Towel hook

**52785**  
Hand shower sliding rail  
consisting of:  
– wall rail, 900 mm  
– sliding bracket for shower head  
– height adjustment via handle,  
tilting angle adjustable  
– spacer disc (5 mm)

**51680**  
Hand shower  
with anti limescale device  
Functions:  
– normal jet  
– soft jet

**54941**  
Exposed part for angle valve DN 15/DN 20  
complete with: handle, sleeve, rosette  
and adjustable extension  
(Angle valve DN 15/DN 20  
to be ordered separately)

**12710**  
Shelf  
with crystalline glass shelf  
Dimensions (w x h x d):  
500 x 120 mm  
650 x 120 mm  
800 x 120 mm  
1000 x 120 mm  
1300 x 120 mm

**12713**  
Towel hook  
double

**12721**  
Towel ring

**52787**  
Hand shower sliding rail set  
consisting of:  
– wall rail, 900 mm  
– sliding bracket for shower head  
– height adjustment via handle,  
tilting angle adjustable  
– spacer disc (5 mm)  
– hand shower with normal jet and soft jet  
– shower hose, 1600 mm

**54991**  
Wall bracket for hand shower  
for shower hoses with conical nuts

**59991**  
Wall bracket for hand shower  
for shower hoses with conical nuts,  
with adjustable tilt angle 20-65°  
Projection: 97 mm

**54947**  
Wall outlet for shower hose DN 15  
suitable for all concealed fittings

**12718/12719**  
Towel holder  
2-arms, fixed  
Projection: 340, 450 mm

**12720/12722**  
Towel holder  
1-arm, fixed  
Projection: 340, 450 mm





12750



12752



12755



12760



12762



12764



12769



04969



12757



12758



12759



12763



12785



12788

**12750**  
**Tumbler holder**  
complete with crystal glass tumbler

**12757**  
**Shower basket for corner**  
metal basket with removable insert  
in white or anthracite  
Dimensions (w x h x d): 180 x 180 x 80 mm

**12752**  
**Lotion dispenser**  
with plastic cup, matt  
in white or anthracite  
Capacity: approx. 180 ml

**12758**  
**Shower basket**  
metal basket with removable insert  
in white or anthracite  
Dimensions (w x h x d): 240 x 110 x 80 mm

**12755**  
**Soap holder**  
complete with crystal glass dish

**12759**  
**Shower basket**  
metal basket with removable insert  
in white or anthracite  
with integrated glass scraper  
Dimensions (w x h x d): 240 x 110 x 91 mm

**12760**  
**Toilet paper holder**  
with lid,  
for 100 mm wide paper rolls

**12762**  
**Toilet paper holder**  
open form,  
for 120 mm wide paper rolls

**12763**  
**Spare paper holder**

**12764**  
**Toilet brush set**  
with lid,  
synthetic insert, brush with handle  
and spare brush head  
in white or anthracite

**12769**  
**Toilet brush set**  
with lid,  
synthetic insert, brush with handle  
and spare brush head  
in white or anthracite

**12785**  
**Paper towel dispenser**  
wall mounted  
in white or anthracite  
with mirror door

**04969**  
**Toilet brush set**  
standing model,  
synthetic insert, brush with handle  
and spare brush head  
in white or anthracite

**12788**  
**Waste bin**  
wall mounted  
in white or anthracite  
Capacity: approx. 25 l

Surfaces:



## SINGLE LEVER MIXER



### 1 WATER DRAW-OFF POINT

Wall outlet for shower hose



Wall outlet for shower hose with hand shower bracket



### 2 WATER DRAW-OFF POINTS

2-way diverter valve



2-way diverter valve with wall outlet for shower hose



2-way diverter valve with wall outlet for shower hose and hand shower bracket



### 3 WATER DRAW-OFF POINTS

3-way diverter valve



3-way diverter valve with wall outlet for shower hose



3-way diverter valve with wall outlet for shower hose and hand shower bracket



All stop and diverter valves also available with handle IXMO Comfort.

## THERMOSTAT



### 1 WATER DRAW-OFF POINT

Stop valve



Stop valve with wall outlet for shower hose



Stop valve with wall outlet for shower hose and hand shower bracket



### 2 WATER DRAW-OFF POINTS

2-way diverter valve



2-way diverter valve with wall outlet for shower hose



2-way diverter valve with wall outlet for shower hose and hand shower bracket



2-way stop and diverter valve



2-way stop and diverter valve with wall outlet for shower hose



2-way stop and diverter valve with wall outlet for shower hose and hand shower bracket



### 3 WATER DRAW-OFF POINTS

3-way diverter valve



3-way diverter valve with wall outlet for shower hose



3-way diverter valve with wall outlet for shower hose and hand shower bracket



3-way stop and diverter valve



3-way stop and diverter valve with wall outlet for shower hose



3-way stop and diverter valve with wall outlet for shower hose and hand shower bracket





**59551**  
**Single lever mixer DN 15**  
Mixing cartridge with ceramic sealing gaskets, temperature controlled, set complete with:  
handle, sleeve, rosette (round or square) and installation unit,  
suitable for rough part no. 59551/000070



**59551**  
**Installation unit for single lever mixer DN 15**  
Rough part for recessed installation



**59553**  
**Thermostat battery DN 15**  
Set complete with:  
handle, sleeve and rosette (round or square)  
suitable for rough part no. 59553/000070



**59553**  
**Installation unit for thermostat battery DN 15**  
Rough part for recessed installation



**59556**  
**2-way diverter valve DN 15**  
Set complete with:  
handle, casing, rosette (round or square) and diverter valve  
suitable for rough part no. 59556/000070



**59556**  
**Installation unit for 2-way diverter valve DN 15**  
Rough part for recessed installation



**59547**  
**Wall outlet for shower hose DN 15**  
with round or square decorative disc,  
intrinsically safe against backflow  
Projection: 55 mm



**59556**  
**2-way diverter valve with wall outlet for shower hose DN 15**  
Set complete with:  
handle, casing, rosette (round or square) and diverter valve,  
intrinsically safe against backflow,  
suitable for rough part no. 59556/000170



**59556**  
**Installation unit for 2-way diverter valve with wall outlet for shower hose DN 15**  
Rough part for recessed installation



**59592**  
**Wall outlet for shower hose with hand shower bracket DN 15**  
for shower hoses with fitted conical end brackets,  
with round or square decorative disc,  
intrinsically safe against backflow



**59556**  
**2-way diverter valve with wall outlet for shower hose and hand shower bracket DN 15**  
Set complete with:  
handle, casing, rosette (round or square) and diverter valve,  
intrinsically safe against backflow,  
suitable for rough part no. 59556/000170



**59556**  
**Installation unit for 2-way diverter valve with wall outlet for shower hose DN 15**  
Rough part for recessed installation



**59541**  
**Stop valve DN 15**  
Set complete with:  
handle, casing, rosette (round or square) and stop cock  
suitable for rough part no. 59541/000070



**59541**  
**Installation unit for stop valve DN 15**  
Rough part for recessed installation



**59557**  
**2-way stop and diverter valve DN 15**  
Set complete with:  
handle, casing, rosette (round or square) and stop and diverter valve  
suitable for rough part no. 59556/000070



**59556**  
**Installation unit for 2-way diverter valve DN 15**  
Rough part for recessed installation



**59541**  
**Stop valve with wall outlet for shower hose DN 15**  
Set complete with:  
handle, casing, rosette (round or square) and stop cock,  
intrinsically safe against backflow,  
suitable for rough part no. 59541/000170



**59541**  
**Installation unit for stop valve with wall outlet for shower hose DN 15**  
Rough part for recessed installation



**59557**  
**2-way stop and diverter valve with wall outlet for shower hose DN 15**  
Set complete with:  
handle, casing, rosette (round or square) and stop and diverter valve,  
intrinsically safe against backflow,  
suitable for rough part no. 59556/000170



**59556**  
**Installation unit for 2-way diverter valve with wall outlet for shower hose DN 15**  
Rough part for recessed installation



**59541**  
**Stop valve with wall outlet for shower hose and hand shower bracket DN 15**  
Set complete with:  
handle, casing, rosette (round or square) and stop cock,  
intrinsically safe against backflow,  
suitable for stop cock no. 59541/000170



**59541**  
**Installation unit for stop valve with wall outlet for shower hose DN 15**  
Rough part for recessed installation



**59557**  
**2-way stop and diverter valve with wall outlet for shower hose and hand shower bracket DN 15**  
Set complete with:  
handle, casing, rosette (round or square) and stop and diverter valve,  
intrinsically safe against backflow,  
suitable for rough part no. 59556/000170



**59556**  
**Installation unit for 2-way diverter valve with wall outlet for shower hose DN 15**  
Rough part for recessed installation



**59548**  
**3-way diverter valve DN 15**  
Set complete with:  
handle, casing, rosette (round or square) and diverter valve  
suitable for rough part no. 59548/000070



**59548**  
**Installation unit for**  
**3-way diverter valve DN 15**  
Rough part for recessed installation



**59548**  
**3-way diverter valve with wall outlet for shower hose DN 15**  
Set complete with:  
handle, casing, rosette (round or square) and diverter valve,  
intrinsicly safe against backflow,  
suitable for rough part no. 59548/000170



**59548**  
**Installation unit for**  
**3-way diverter valve with wall**  
**outlet for shower hose DN 15**  
Rough part for recessed installation



**59548**  
**3-way diverter valve with wall outlet for shower hose**  
**and hand shower bracket DN 15**  
Set complete with:  
handle, casing, rosette (round or square) and diverter valve,  
intrinsicly safe against backflow,  
suitable for rough part no. 59548/000170



**59548**  
**Installation unit for**  
**3-way diverter valve with wall**  
**outlet for shower hose DN 15**  
Rough part for recessed installation



**59549**  
**3-way stop and diverter valve DN 15**  
Set complete with:  
handle, casing, rosette (round or square) and stop and diverter valve  
suitable for rough part no. 59548/000070



**59548**  
**Installation unit for**  
**3-way diverter valve DN 15**  
Rough part for recessed installation



**59549**  
**3-way stop and diverter valve with wall outlet**  
**for shower hose DN 15**  
Set complete with:  
handle, casing, rosette (round or square) and stop and diverter valve,  
intrinsicly safe against backflow,  
suitable for rough part no. 59548/000170



**59548**  
**Installation unit for**  
**3-way diverter valve with wall**  
**outlet for shower hose DN 15**  
Rough part for recessed installation



**59549**  
**3-way stop and diverter valve with wall outlet for shower hose**  
**and hand shower bracket DN 15**  
Set complete with:  
handle, casing, rosette (round or square) and stop and diverter valve,  
intrinsicly safe against backflow,  
suitable for rough part no. 59548/000170



**59548**  
**Installation unit for**  
**3-way diverter valve with wall**  
**outlet for shower hose DN 15**  
Rough part for recessed installation



EDITION 400



EDITION 11



PLAN S



PLAN Blue



ELEGANCE



COLLECTION MOLL

**59551**

**59551**  
**Single lever mixer / handles**  
handles matching the recessed  
single lever mixers no. 59551/019501,  
59551/019502

**59541/59556/59557/59548/59549****59545****59547**

**Handle IXMO Comfort Plus**  
for all stop and diverter valves,  
with adjustment facilities for  
twisted recessed wall installation  
of the basic unit

**59541** – for stop valves  
**59556** – for 2-way diverter valves  
**59557** – for 2-way stop and diverter valves  
**59548** – for 3-way diverter valves  
**59549** – for 3-way stop and diverter valves

**Note:**  
for the vertical alignment of the handle

**59545**  
**Bath filler/spout DN 15**  
with round or square rosette,  
suitable for all concealed fittings  
Projection: 130, 180 mm

**59547**  
**Universal installation unit G 1/2**  
for an easy fitting of products with 1/2 inch  
connection in combination with mounting rail,  
internal thread G 1/2

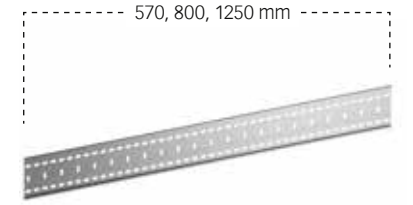
**59516****59916****59570**

**59516**  
**Single lever basin mixer**  
concealed fitting DN 15,  
cartridge mixer with ceramic sealing gaskets,  
aerator SLIM SSR M 24 x 1,  
adjustable flow angle,  
flow rate limited to 7,6 l/min.  
(essential for installation:  
rough part article No. 59916  
to be ordered separately)  
Projection: 187, 219, 265 mm

**59916**  
**Installation unit for single lever basin mixer**  
Rough part for recessed installation  
Installation depth: 70-100 mm

**59570**  
**IXMO Mounting rail**  
for an easy and steplessly adjustable installation  
of the IXMO function units  
Length: 570, 800, 1250 mm



59553



59551



59949

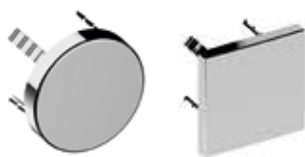

59949



59551



59553



59556



59556



59552



59552



51187



51587



59587

**59553****Extension rosette**

25 mm, round or square, brass, for installation between tiles and finish set for installation of stop and diverter valve in walls with a low wall thickness, installation depth 55-80 mm, suitable for rough part art. no. 59553/000070

**59551****Extension rosette**

25 mm, round or square, brass, for installation between tiles and finish set for installation of stop and diverter valve in walls with a low wall thickness, installation depth 55-80 mm, suitable for rough part art. no. 59541/000070, 59541/000170, 59548/000070, 59548/000170, 59556/000070, 59556/000170

**59551****Extension rosette**

25 mm, round or square, brass, with red/blue marker, for installation between tiles and finish set for installation of stop and diverter valve in walls with a low wall thickness, installation depth 55-80 mm, suitable for rough part art. no. 59556/000070

**59949****Tube interrupter**

in accordance with DIN EN 1717 in a wall mounting box with chrome-plated cover (round)

**Note:**

Behind the tube interrupter is no shutoff allowed. Installation only in a vertical position.

**59949****Cover cap**

round (90 mm Ø) or square (90 x 90 mm), for tube interrupter article no. 59949/000070

**59551****Extension set for single lever mixer**

30 mm (installation depth 110-140 mm), for base structure 59551/000070

**59553****Extension set for thermostatic mixer**

30 mm (installation depth 110-140 mm), for base structure 59553/000070

**59556****Extension set for stop and diverter valve**

30 mm (installation depth 110-140 mm), for base structure 59541/000070, 59556/000070, 59548/000070

**59556****Extension set for stop and diverter valve with wall outlet for shower hose**

30 mm (installation depth 110-140 mm), for base structure 59541/000170, 59556/000170, 59548/000170

**59552****Set consisting of:****– Single-lever mixer with wall outlet for shower hose DN 15**

Mixing cartridge with ceramic sealing gaskets, temperature limiter and flow rate limiter, wall outlet for shower hose intrinsically safe against backflow in accordance with DIN EN 1717, 90 mm projection

**Finish set consisting of:**

lever, sleeve, decor disc (round or rectangular), installation unit and wall outlet for shower hose

**– In-wall installation unit for single-lever mixer with wall outlet for shower hose DN 15**

Rough part for recessed installation, installation depth 65-95 mm

**Classification according to noise group I and flow rate class A****51187****Shower set****consisting of:**

- 900 mm rail with sliding bracket for shower head, height adjustment with handle, tilt angle adjustable to any position
- hand shower with normal jet
- 1600 mm shower hose
- tile compensation plate (5 mm)

**51587****Shower set****consisting of:**

- 900 mm rail with sliding bracket for shower head, height adjustment with handle, tilt angle adjustable to any position
- hand shower with normal, soft and massage jet
- 1600 mm shower hose
- tile compensation plate (5 mm)

**59587****Shower set****consisting of:**

- 800 mm rail with sliding bracket for shower head, height adjustment with handle, tilt angle adjustable to any position
- hand shower with normal jet
- 1600 mm shower hose
- tile compensation plate (5 mm)

Glass colour variations

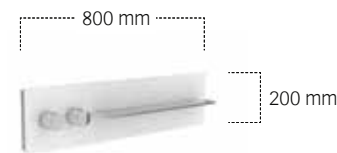
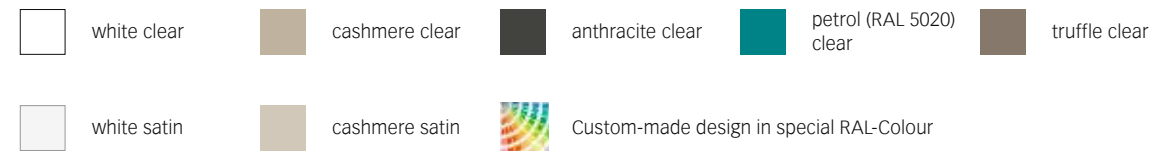

56161

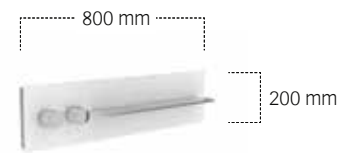

56162

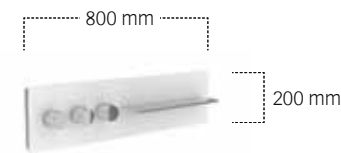

56163

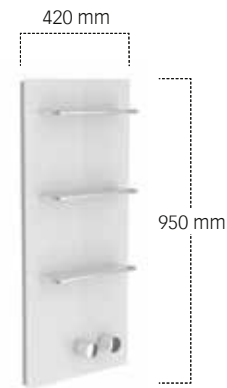

56164

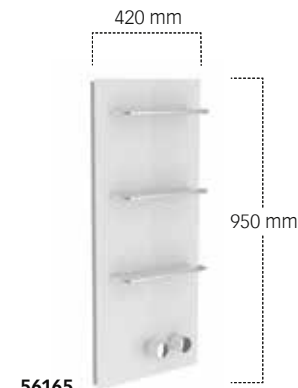

56165

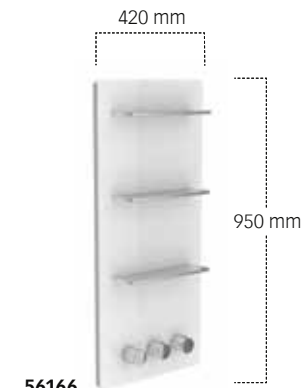

56166



59948



59982



59993



59996

**56161**  
**Shower and bathtub board with thermostat battery DN20**  
 Finish set for the regulation of 1 user handles as desired left or right complete with:  
 – Mounting frame  
 – Panel made of ESG glass, with frame and one shelf made of aluminium  
 – Knob for thermostat with safety cut-off at 38 °C  
 – Shut-off handle  
 Dimensions (w x h): 800 x 200 mm (essential for installation: rough part article no. 56161 000071 to be ordered separately)

**56164**  
**Shower board with thermostat battery DN20**  
 Finish set for the regulation of 1 user handles right, complete with:  
 – Mounting frame  
 – Panel made of ESG glass, with frame and three shelves made of aluminium  
 – Knob for thermostat with safety cut-off at 38 °C  
 – Shut-off handle  
 Dimensions (w x h): 420 x 950 mm (essential for installation: rough part article no. 56161 000071 to be ordered separately)

**56162**  
**Shower and bathtub board with thermostat battery DN20**  
 Finish set for the regulation of 2 users handles as desired left or right with/without safety device complete with:  
 – Mounting frame  
 – Panel made of ESG glass, with frame and one shelf made of aluminium  
 – Knob for thermostat with safety cut-off at 38 °C  
 – Shut-off and adjustment handle  
 Dimensions (w x h): 800 x 200 mm (essential for installation: rough part article no. 56162 000072 to be ordered separately)

**56165**  
**Shower board with thermostat battery DN20**  
 Finish set for the regulation of 2 users handles right, complete with:  
 – Mounting frame  
 – Panel made of ESG glass, with frame and three shelves made of aluminium  
 – Knob for thermostat with safety cut-off at 38 °C  
 – Shut-off and adjustment handle  
 Dimensions (w x h): 420 x 950 mm (essential for installation: rough part article no. 56162 000072 to be ordered separately)

**56163**  
**Shower and bathtub board with thermostat battery DN20**  
 Finish set for the regulation of 3 users handles as desired left or right complete with:  
 – Mounting frame  
 – Panel made of ESG glass, with frame and one shelf made of aluminium  
 – Knob for thermostat with safety cut-off at 38 °C  
 – Shut-off handle  
 – Adjustment grip  
 Dimensions (w x h): 800 x 200 mm (essential for installation: rough part article no. 56163 000073 to be ordered separately)

**56166**  
**Shower board with thermostat battery DN20**  
 Finish set for the regulation of 3 users handles right, complete with:  
 – Mounting frame  
 – Panel made of ESG glass, with frame and three shelves made of aluminium  
 – Knob for thermostat with safety cut-off at 38 °C  
 – Shut-off handle  
 – Adjustment grip  
 Dimensions (w x h): 420 x 950 mm (essential for installation: rough part article no. 56163 000073 to be ordered separately)

**59948**  
**Exposed part for 3-way diverter valve UP**  
 complete with:  
 handle, sleeve, rosette (round/square)

**59982**  
**Waterfall shower**  
 for wall connection G 1/2 Inch restricted flow rate 25 l/min.

**59993**  
**Wall outlet for shower hose DN20**  
 with wall bracket, for SPA hose, suitable for all concealed fittings with backflow preventer

**59996**  
**SPA hose**  
 with chrome-plated shower bracket for wall connection elbow and chrome-plated hose connection 3/4"

**EDITION 300**

Surface:

 chrome-plated



**30010**



**30015**



**30018 / 30019**



**30021**



**30050**

**30052**



**30055**



**30063**



**30060**



**30064**



**30070**

**30010**  
**Shelf**  
with crystalline glass shelf, underside matt  
Dimensions (w x h):  
650 x 120 mm  
950 x 120 mm  
1250 x 120 mm

**30021**  
**Towel ring**  
Ø 210 mm  
Projection: 212 mm

**30063**  
**Spare paper holder**

**30060**  
**Toilet paper holder**  
with lid,  
for 100/120 mm wide paper rolls

**30015**  
**Towel hook**  
double

**30050**  
**Tumbler holder**  
complete with crystal glass tumbler, matt

**30052**  
**Lotion dispenser**  
complete with crystal glass tumbler, matt  
Capacity: approx. 180 ml

**30064**  
**Toilet brush set**  
complete with crystal glass insert, matt  
and brush

**30018 / 30019**  
**Towel holder**  
fixed  
Projection: 320, 465 mm

**30055**  
**Soap holder**  
complete with crystal glass dish, matt

**30070**  
**Towel holder**  
holds 6 guest towels  
(approx. 30 x 50 cm)

**ASTOR**

Surface:

 chrome-plated

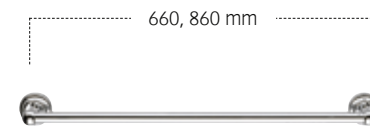

**02101**



**02107**

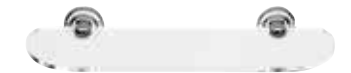

**02110**



**02117**



**02118**



**02114 / 02116**



**02121**



**02150**



**02155**

**02101**  
**Towel rail**  
600, 800 mm

**02117**  
**Towel holder**  
1-arm, fixed  
Projection: 434 mm

**02121**  
**Towel ring**  
Ø 175 mm

**02107**  
**Grab bar / Towel rail (USA)**  
300 mm

**02118**  
**Towel holder**  
2-arms, swivelling  
Projection: 465 mm

**02150**  
**Tumbler holder**  
complete with crystal glass tumbler

**02110**  
**Shelf**  
with crystalline glass shelf  
Dimensions (w x h):  
450 x 120 mm  
650 x 120 mm

**02114 / 02116**  
**Towel hook**  
**Robe hook**

**02155**  
**Soap holder**  
complete with crystal glass dish



02152



02153



02160



02163



02164



03864

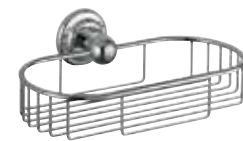

02158

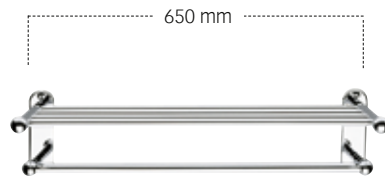

02175



02191

**02152**  
**Lotion dispenser**  
complete with opal glass, matt  
Capacity: approx. 160 ml

**02163**  
**Spare paper holder**

**02158**  
**Sponge wire basket**

**02153**  
**Lotion dispenser**  
complete with opal glass, matt  
Capacity: approx. 250 ml

**02164**  
**Toilet brush set**  
complete with matt crystal glass insert and brush

**02175**  
**Towel rack**  
600 mm

**02160**  
**Toilet paper holder**  
with lid

**03864**  
**Toilet brush set**  
with lid,  
complete with brush and spare brush head

**02191**  
**Wall decor disk**  
chrome-plated, gold-plated

Surface:  
chrome-plated

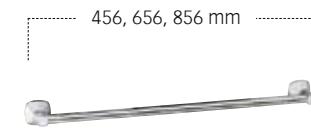

02701



02707



02710



02714



02715



02718



02721



02750



02751



02753



02755



02760



02762



02763



02764

**02701**  
**Towel rail**  
400, 600, 800 mm

**02714**  
**Towel hook**

**02715**  
**Towel hook**

**02753**  
**Lotion dispenser**  
complete with crystal glass, matt  
Capacity: approx. 250 ml

**02755**  
**Soap holder**  
complete with crystal or acrylic glass dish

**02707**  
**Grab bar/Towel rail (USA)**  
250 mm

**02718**  
**Towel holder**  
2-arms, swivelling  
Projection: 430 mm

**02721**  
**Towel ring**  
Ø 192 mm

**02760**  
**Toilet paper holder**  
with lid

**02762**  
**Toilet paper holder**  
open form

**02710**  
**Shelf**  
with crystal glass shelf  
Dimensions (w x h):  
450 x 120 mm  
650 x 120 mm

**02750**  
**Tumbler holder**  
complete with crystal or acrylic glass tumbler

**02751**  
**Double tumbler holder**  
complete with crystal or acrylic glass tumblers

**02763**  
**Spare paper holder**

**02764**  
**Toilet brush set**  
complete with with synthetic insert,  
brush and spare brush head



Surface:

 chrome-plated



14701



14707



14714



14752



14755



14758



14718

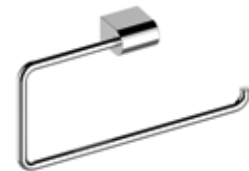

14721



14750



14762



14763

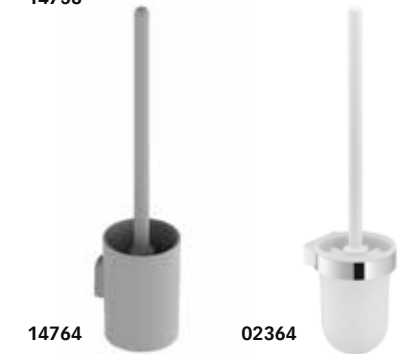

14764

02364

**14701**  
**Towel rail**  
600, 800 mm

**14707**  
**Grab bar**  
300 mm

**14714**  
**Towel hook**

**14752**  
**Lotion dispenser**  
opaque synthetic matt  
Capacity: approx. 200 ml  
Dosage: approx. 0.5 ml/stroke

**14755**  
**Soap holder**  
with detachable crystal glass dish

**14758**  
**Shower basket**  
with detachable synthetic insert, white  
Dimensions (w x d): 242 x 120 mm

**14718**  
**Towel holder**  
2-arms, swivelling  
Projection: 440 mm

**14721**  
**Towel ring**  
open form

**14750**  
**Tumbler holder**  
complete with crystal glass tumbler

**14762**  
**Toilet paper holder**  
open form,  
for 120 mm wide paper rolls

**14763**  
**Spare paper holder**

**14764/02364**  
**Toilet brush set**  
complete with synthetic insert and brush, white

Surface:



chrome-plated



14977



04988



04979



11650



11653



11654



04909



14949



14952



11655

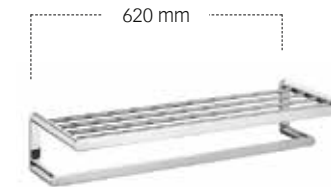

11675

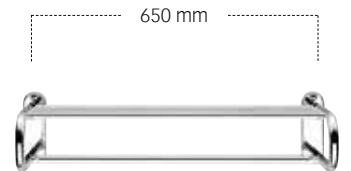

04975



11649



04960



04972



11667



04976



04977

04985

**14977**  
**Sanitary waste bin**  
wall mounted  
Capacity: 3 l

**04988**  
**Waste bin**  
with detachable black insert  
Capacity: 5 l

**04979**  
**Clothes line**  
complete with wall mounting element  
extendable up to max. 2.80 m

**11650**  
**Tumbler holder**  
table model  
complete with crystal glass tumbler, matt

**11653**  
**Foam soap dispenser**  
table model  
opal glass, matt  
including foam soap (2 x 500 ml)  
Capacity: approx. 220 ml

**11654**  
**Lotion dispenser**  
table model  
opal glass, matt  
Capacity: approx. 220 ml

**04909**  
**Grab bar / Towel rail (USA)**  
with soap holder and drainage slots

**14949**  
**Built in soap dispenser**  
for mounting on washbasin  
or washbasin worktop  
Capacity: approx. 500 ml

**14952**  
**Lotion dispenser standing model**  
Capacity: approx. 250 ml

**11655**  
**Soap holder**  
table model  
complete with removable crystal glass dish, matt

**11675**  
**Towel rack**  
620 mm

**04975**  
**Towel rack**  
650 mm

**11649**  
**Soap dispenser**  
for mounting on washbasin or washbasin worktop,  
including foam soap (2 x 500 ml),  
also available for liquid soap  
Capacity: approx. 500 ml  
Height: 93 mm

**04960**  
**Toilet paper holder**  
for wall mounting

**04972**  
**Guest towel basket**

**11667**  
**Moisture box**  
comes with porcelain box, white

**04976**  
**Hygiene bag dispenser**  
ABS plastic for max. 25 bags,  
including first 25 bags

**04977 / 04985**  
**Tissue box**  
with closed sides, for up to max. 150 sheets



01680



04980



14982



11682



14966-14971



14995



04996/04997



11172



11170



30070



03864



04969



12769



16064



16062



16052

**01680**  
**Tip-up seat**  
with Keucolit-seat, white

**14982**  
**Bathroom stool**  
also suitable for wet rooms  
seat white, dark grey or light grey  
Surface chrome-plated  
or aluminium silver-anodized (E6 EV1)

**14995**  
**Hair dryer**  
with wall mounting element, 230 V  
Features:  
– On-off switch with indicator light  
on the wall holder  
– 3 heating levels up to max. 1800 W  
– 2 speed levels  
– Cold air button  
– Overheating protection

**04980**  
**Shower seat**  
for wall mounting,  
soft seat, fixed  
seat size: 450 mm wide  
Colour variations:  
truffle, cashmere, dark grey, white  
Dimensions (w x h x d):  
450 x 330 x 90 mm

**11682**  
**Bathroom stool**  
chrome-plated, walnut veneer

**04996/04997**  
**Hair dryer holder**  
usable on left or right

**14966**  
**Doorplate**  
Symbol Ladies

**14967**  
**Doorplate**  
Symbol Gents

**14968**  
**Doorplate**  
Symbol Disabled

**14971**  
**Doorplate**  
Symbol Ladies/Gents

**11172**  
**Guest towel basket**  
removable,  
MDF white lacquered  
Dimensions (w x h x d): 200 x 350 x 200 mm

**11170**  
**Towel holder**  
holds 6 guest towels  
(approx. 30 x 50 cm)

**30070**  
**Towel holder**  
holds 6 guest towels  
(approx. 30 x 50 cm)

**03864**  
**Toilet brush set**  
with lid,  
complete with brush and spare brush head

**04969**  
**Toilet brush set**  
standing model, with lid,  
complete with synthetic insert,  
brush with handle and spare brush head  
in white or anthracite

**16062**  
**Toilet paper double holder**  
for 100/120 mm wide paper rolls

**12769**  
**Toilet brush set**  
with lid,  
synthetic insert, brush with handle  
and spare brush head  
in white or anthracite

**16064**  
**Toilet brush set**  
standing model,  
complete with glass insert, brush  
and spare brush head

**16052**  
**Soap dispenser**  
table model  
including foam soap (2 x 500 ml)  
Capacity: approx. 150 ml  
Height: 195 mm

## SOAP BASKETS

Surface:

chrome-plated



24901/24902

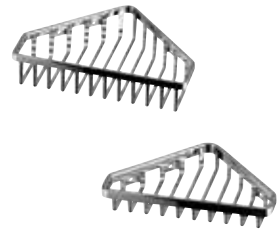

24903/24904



24941



24942



24943



24944



11657



11658



11158

11159



12757



12758



12759



11558



11559

**24901**  
**Soap wire basket**  
Dimensions (w x h x d): 132 x 100 x 28 mm

**24902**  
**Sponge wire basket**  
Dimensions (w x h x d): 200 x 100 x 28 mm

**24942**  
**Sponge basket**  
removable, with concealed fastening screws  
Dimensions (w x h x d):  
200 x 114 x 28 mm  
200 x 114 x 70 mm

**24903**  
**Soap wire basket for corner installation**  
Side length: 127 mm  
Dimensions (w x h x d): 180 x 115 x 28 mm

**24904**  
**Sponge basket for corner installation**  
Side length: 170 mm  
Dimensions (w x h x d): 240 x 170 x 50 mm

**24943**  
**Soap wire basket for corner installation**  
removable, with concealed fastening screws  
Side length: 140 mm  
Dimensions (w x h x d): 197 x 133 x 28 mm

**24941**  
**Soap wire basket**  
removable, with concealed fastening screws  
Dimensions (w x h x d): 132 x 105 x 28 mm

**24944**  
**Sponge basket for corner installation**  
removable, with concealed fastening screws  
Side length: 186 mm  
Dimensions (w x h x d):  
264 x 180 x 47 mm  
260 x 180 x 72 mm

**11657**  
**Sponge basket for corner installation**  
metal basket with removable insert  
in white or anthracite  
Dimensions (w x h x d): 180 x 180 x 70 mm

**12757**  
**Shower basket for corner**  
metal basket with removable insert  
in white or anthracite  
Dimensions (w x h x d): 180 x 180 x 80 mm

**11558**  
**Shower shelf**  
aluminium silver-anodized (E6 EV1)

**11658**  
**Sponge basket**  
metal basket with removable insert  
in white or anthracite  
Dimensions (w x h x d): 239 x 105 x 70 mm

**12758**  
**Shower basket**  
metal basket with removable insert  
in white or anthracite  
Dimensions (w x h x d): 240 x 110 x 80 mm

**11559**  
**Shower shelf**  
aluminium silver-anodized (E6 EV1)  
with integrated glass scraper (white)

**11158**  
**Shower basket**  
aluminium silver-anodized/chrome-plated  
Dimensions (w x h x d): 300 x 95 x 67 mm

**11159**  
**Shower basket**  
aluminium silver-anodized/chrome-plated  
with integrated glass scraper  
Dimensions (w x h x d): 300 x 95 x 67 mm

**12759**  
**Shower basket**  
metal basket with removable insert  
in white or anthracite  
with integrated glass scraper  
Dimensions (w x h x d): 240 x 110 x 91 mm

Surface:



chrome-plated



17612



17612



17612



17613



17613



17613



17612



17612



17613



17613

**17612****Cosmetic mirror round**

illuminated, 5-stage adjustable light colour from 2700 kelvin (warm white) to 6500 kelvin (daylight) spiral cord (block length 400 mm)

on pivoted rail adjustable in three dimensions one-sided mirror, magnification factor x 5

Operation:

Glass control panel with capacitive touch sensor and LED display

Power supply:

Mains connection via wall socket, 12 V in-wall adapter, input 220-240 V, standby consumption: < 0.5 watt

Illumination: LED 4.5 watt

Ø 212 mm

**17612****Cosmetic mirror round**

illuminated, 5-stage adjustable light colour from 2700 kelvin (warm white) to 6500 kelvin (daylight), in-wall cable layout,

on pivoted rail adjustable in three dimensions, one-sided mirror, magnification factor x 5

Operation:

Glass control panel with capacitive touch sensor and LED display

Power supply:

Mains connection via wall socket, 12 V in-wall adapter, input 220-240 V, standby consumption: < 0.5 watt

Illumination: LED 4.5 watt

suitable for rough part no. 17699

Ø 212 mm

**17612****Cosmetic mirror round**

illuminated, 1 light colour 6500 kelvin (day light), spiral cord (block length 400 mm),

on pivoted rail adjustable in three dimensions,

one-sided mirror, magnification factor x 5

Operation: Cable switch

Power supply:

Mains connection via plug-in power supply unit, 12 V Plug-in power supply unit, input 100-240 V,

Standby consumption: < 0.3 watt

Illumination: LED 4.5 watt

Ø 212 mm

**17612****Cosmetic mirror round**

illuminated, 1 light colour 6500 kelvin (day light), in-wall cable layout,

on pivoted rail adjustable in three dimensions,

one-sided mirror, magnification factor x 5

Operation:

Light switch (not included in delivery)

Power supply:

Mains connection via wall socket

12 V in-wall adapter, input 220-240 V,

standby consumption: 0 watt

Illumination: LED 4.5 watt

suitable for rough part no. 17699

Ø 212 mm

**17612****Cosmetic mirror round**

non illuminated,

on pivoted rail adjustable in three dimensions,

one-sided mirror, magnification factor x 5

Ø 212 mm

**17613****Cosmetic mirror squared**

illuminated, 5-stage adjustable light colour from 2700 kelvin (warm white) to 6500 kelvin (daylight) spiral cord (block length 400 mm)

on pivoted rail adjustable in three dimensions one-sided mirror, magnification factor x 5

Operation:

Glass control panel with capacitive touch sensor and LED display

Power supply:

Mains connection via wall socket, 12 V in-wall adapter, input 220-240 V, standby consumption: < 0.5 watt

Illumination: LED 4.5 watt

Exterior measurement: 200 x 200 mm

**17613****Cosmetic mirror squared**

illuminated, 5-stage adjustable light colour from 2700 kelvin (warm white) to 6500 kelvin (daylight), in-wall cable layout,

on pivoted rail adjustable in three dimensions, one-sided mirror, magnification factor x 5

Operation:

Glass control panel with capacitive touch sensor and LED display

Power supply:

Mains connection via wall socket, 12 V in-wall adapter, input 220-240 V, standby consumption: < 0.5 watt

Illumination: LED 4.5 watt

suitable for rough part no. 17699

Exterior measurement: 200 x 200 mm

**17613****Cosmetic mirror squared**

illuminated, 1 light colour 6500 kelvin (day light), spiral cord (block length 400 mm),

on pivoted rail adjustable in three dimensions,

one-sided mirror, magnification factor x 5

Operation: Cable switch

Power supply:

Mains connection via plug-in power supply unit, 12 V Plug-in power supply unit, input 100-240 V,

Standby consumption: < 0.3 watt

Illumination: LED 4.5 watt

Exterior measurement: 200 x 200 mm

**17613****Cosmetic mirror squared**

illuminated, 1 light colour 6500 kelvin (day light), in-wall cable layout,

on pivoted rail adjustable in three dimensions,

one-sided mirror, magnification factor x 5

Operation:

Light switch (not included in delivery)

Power supply:

Mains connection via wall socket

12 V in-wall adapter, input 220-240 V,

standby consumption: 0 watt

Illumination: LED 4.5 watt

suitable for rough part no. 17699

Exterior measurement: 200 x 200 mm

**17613****Cosmetic mirror squared**

non illuminated,

on pivoted rail adjustable in three dimensions,

one-sided mirror, magnification factor x 5

Exterior measurement: 200 x 200 mm

Surface:



chrome-plated



17649



17605



17606



17676



17677

**17649**  
**Cosmetic mirror**  
non illuminated, with pivoting arm,  
adjustable in three dimensions,  
magnification factor x 2.5, Ø 190 mm

**17605**  
**Cosmetic mirror Bella Vista**  
illuminated, wall model,  
with mains connection through wall socket  
or helix cable and power plug,  
1 x 8 W LED  
magnification factor x 3, Ø 218 mm

**17606**  
**Cosmetic mirror Bella Vista**  
illuminated, table model,  
with mains connection through  
wall socket (1,70 m),  
1 x 8 W LED  
magnification factor x 3, Ø 218 mm

**17676**  
**Cosmetic mirror**  
illuminated, wall model,  
optionally with mains connection through wall socket  
or with spiral cord and plug,  
1 x 8 W energy efficient lamp  
magnification factor x 5, Ø 207 mm

**17677**  
**Cosmetic mirror**  
illuminated, table model,  
with power lead (1,70 m),  
1 x 8 W energy-efficient light lamp  
magnification factor x 5, Ø 207 mm



11596



11597



11195



11596



11597



11196



11596



11597



11198

**11496**  
**Light mirror customized**  
Features as 11596  
Dimensions (w x h x d):  
720–2110 x 650 x 33 mm

**11596**  
**Light mirror**  
adjustable light colour from 2700 kelvin (warm white)  
to 6500 kelvin (daylight),  
continuous aluminium frame,  
optionally with mirror heating  
Operation:  
key panel with capacitive touch sensor,  
integrated extension function for e.g. light switch  
Illumination:  
LED, infinitely variable dimming  
Dimensions (w x h x d):  
535 x 650 x 33 mm  
710 x 650 x 33 mm  
1060 x 650 x 33 mm  
1410 x 650 x 33 mm

**11497**  
**Light mirror customized**  
Features as 11597  
Dimensions (w x h x d):  
720–2110 x 650 x 33 mm

**11597**  
**Light mirror**  
1 light colour, 4000 kelvin (neutral white)  
continuous aluminium frame  
Operation:  
key panel with capacitive touch sensor,  
optionally to be operated via the light switch  
Illumination:  
LED, infinitely variable dimming  
Dimensions (w x h x d):  
535 x 650 x 33 mm  
710 x 650 x 33 mm  
1060 x 650 x 33 mm  
1410 x 650 x 33 mm

**11195**  
**Crystal mirror**  
Dimensions (w x h x d):  
535/700/1050/1400/1750/2100/2450/2800  
x 610 x 26 mm

**11196**  
**Light mirror**  
2 laterally illuminated side wings,  
each pivoting up to 90° with tilting mirror,  
concealed light switch  
Lighting:  
– fluorescent lamps (4 x 14 W T5)  
Dimensions (w x h x d):  
1050/1400/1750/2100/2450/2800/3150  
x 610 x 68 mm

**11198**  
**Light mirror**  
with integrated shelf,  
concealed light switch  
Lighting:  
– LED lamp (2 x 6.8 W),  
Dimensions (w x h x d): 435 x 900 x 128 mm



30095



30096



30095



30096



30496

**30095**  
**Crystal mirror**  
with all round facet cut  
Dimensions (w x h):  
525 x 960 mm  
650 x 650 mm  
950 x 650 mm  
1250 x 650 mm

**30096**  
**Light mirror**  
with lighting on all sides:  
– fluorescent lamps (4 x 14 W T5)  
Dimensions (w x h x d): 650 x 650 x 65 mm

**30096**  
**Light mirror**  
with lighting on all sides  
Fluorescent lamps/Dimensions (w x h x d):  
2 x 14 W T5 and 2 x 21 W T5 / 950 x 650 x 65 mm  
2 x 14 W T5 and 2 x 28 W T5 / 1250 x 650 x 65 mm

**30496**  
**Light mirror**  
with light switch,  
with vertical lighting:  
– fluorescent lamps (2 x 14 W T5)  
Dimensions (w x h x d): 525 x 960 x 46 mm

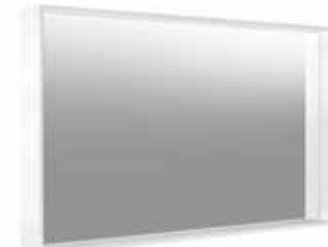
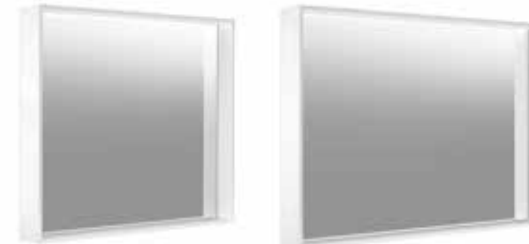

07895

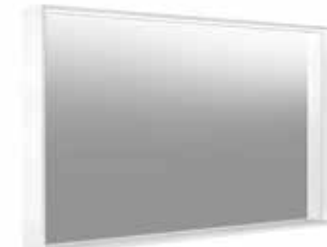
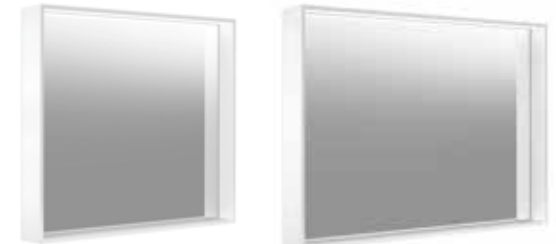

07896

**07895**  
**Crystal mirror**  
non illuminated,  
continuous aluminium frame, silver-anodized  
Dimensions (w x h x d):  
500 x 700 x 105 mm  
650 x 700 x 105 mm  
800 x 700 x 105 mm  
1000 x 700 x 105 mm  
1200 x 700 x 105 mm

**07896**  
**Light mirror**  
1 light colour, 3000 kelvin (daylight),  
continuous aluminium frame, silver-anodized  
Operation:  
– key panel with capacitive touch sensor,  
– optionally to be operated via the light switch  
Illumination:  
– LED (lifespan > 30000 hours)  
– main light (top light and wall light), and washbasin  
lighting separately infinitely dimmable and can be  
switched on/off,  
lamps non-exchangeable  
Dimensions (w x h x d):  
500 x 700 x 105 mm / 27 watt  
650 x 700 x 105 mm / 30 watt  
800 x 700 x 105 mm / 33 watt  
1000 x 700 x 105 mm / 42 watt  
1200 x 700 x 105 mm / 48 watt



07897

07898

**07897**  
**Light mirror**  
 adjustable light colour from 2700 kelvin (warm white) to 6500 kelvin (daylight), continuous aluminium frame, silver-anodized  
 Operation:  
 – key panel with capacitive touch sensor,  
 – integrated extension function for e.g. light switch  
 Illumination:  
 – LED (lifespan > 30000 hours)  
 – main light (top light and wall light), and washbasin lighting separately infinitely dimmable and can be switched on/off,  
 lamps non-exchangeable  
 Dimensions (w x h x d):  
 500 x 700 x 105 mm / 27 watt  
 650 x 700 x 105 mm / 30 watt  
 800 x 700 x 105 mm / 33 watt  
 1000 x 700 x 105 mm / 42 watt  
 1200 x 700 x 105 mm / 48 watt

**07898**  
**Light mirror**  
 with mirror heater, adjustable light colour from 2700 kelvin (warm white) to 6500 kelvin (daylight), continuous aluminium frame, silver-anodized  
 Operation:  
 – key panel with capacitive touch sensor,  
 – integrated extension function for e.g. light switch  
 Illumination:  
 – LED (lifespan > 30000 hours)  
 – main light (top light and wall light), and washbasin lighting separately infinitely dimmable and can be switched on/off,  
 lamps non-exchangeable  
 Dimensions (w x h x d):  
 500 x 700 x 105 mm / 27 watt + 26 watt  
 650 x 700 x 105 mm / 30 watt + 41 watt  
 800 x 700 x 105 mm / 33 watt + 52 watt  
 1000 x 700 x 105 mm / 42 watt + 65 watt  
 1200 x 700 x 105 mm / 48 watt + 82 watt



11692



11695



11697



11696



11698

**11692**  
**Wall light**  
 horizontal or vertical installation, mirrored front panel, both task lighting and moodlight, switched separately via room switch, fluorescent lamps  
 Illumination/Dimensions (w x h x d):  
 2 x 14 W T5/700 x 70 x 66 mm  
 2 x 21 W T5/950 x 70 x 66 mm

**11695**  
**Crystal mirror**  
 with all round facet cut  
 Dimensions (w x h):  
 360 x 635 mm  
 700 x 750 mm  
 950 x 635 mm  
 1300 x 635 mm

**11697**  
**Light mirror**  
 horizontal illumination, mirrored front panel, both task lighting and mood light, concealed switches  
 Lighting:  
 – fluorescent lamp (1 x 24 W)  
 Dimensions (w x h x d): 360 x 705 x 66 mm

**11696**  
**Light mirror**  
 horizontal illumination, mirrored front panel, both task lighting and mood light, switched separately with concealed switches, Fluorescent lamps/Dimensions (w x h x d):  
 2 x 14 W T5/ 700 x 820 x 66 mm  
 2 x 21 W T5/ 950 x 705 x 66 mm  
 2 x 28 W T5/ 1300 x 705 x 66 mm

**11698**  
**Light mirror**  
 vertical illumination, mirrored front panel, both task lighting and mood light, switched separately with concealed switches  
 Lighting:  
 – fluorescent lamps (4 x 14 W T5)  
 Dimensions (w x h x d):  
 700 x 635 x 66 mm  
 950 x 635 x 66 mm  
 1300 x 635 x 66 mm



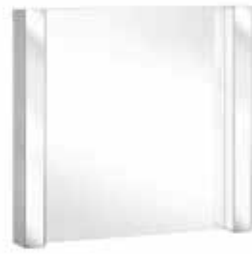

11698



11698

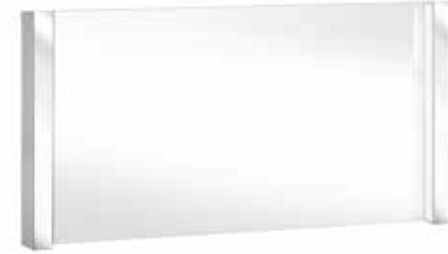

11698



14096

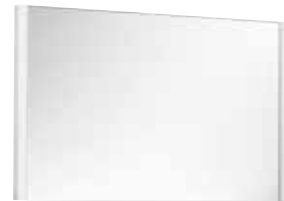

14096

**11698**  
**Light mirror**  
vertical illumination, mirrored front panel,  
both task lighting and mood light,  
switched separately with concealed switches  
Lighting:  
– fluorescent lamps (4 x 14 W T5)  
Dimensions (w x h x d):  
700 x 635 x 66 mm

**11698**  
**Light mirror**  
vertical illumination, mirrored front panel,  
both task lighting and mood light,  
switched separately with concealed switches  
Lighting:  
– fluorescent lamps (4 x 14 W T5)  
Dimensions (w x h x d):  
1050 x 635 x 66 mm

**11698**  
**Light mirror**  
vertical illumination, mirrored front panel,  
both task lighting and mood light,  
switched separately with concealed switches  
Lighting:  
– fluorescent lamps (4 x 14 W T5)  
Dimensions (w x h x d):  
1400 x 635 x 66 mm

**14096**  
**Light mirror**  
vertical illumination, concealed switch,  
Lighting:  
– fluorescent lamps (2 x 21 W T5)  
Dimensions (w x h x d): 500 x 900 x 42 mm

**14096**  
**Light mirror**  
vertical illumination, concealed switch,  
Lighting:  
– fluorescent lamps (2 x 24 W T5 Seamless)  
Dimensions (w x h x d):  
650 x 605 x 42 mm  
800 x 605 x 42 mm  
1000 x 605 x 42 mm  
1300 x 605 x 42 mm



07749/10095



07790

**07749 / 10095**  
**Crystal mirror**  
Dimensions (w x h):  
220 x 800 mm  
350 x 850 mm  
550 x 850 mm

**07790**  
**Crystal mirror**  
with facet cut and polished edges  
Dimensions (w x h):  
450 x 800 mm  
650 x 900 mm



11695

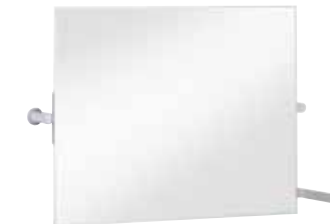

34986

**11695**  
**Crystal mirror**  
with all round facet cut  
Dimensions (w x h):  
360 x 635 mm  
700 x 750 mm  
950 x 635 mm  
1300 x 635 mm

**34986**  
**Tiltable mirror**  
also suitable for installation with wall offset  
Dimensions (w x h): 600 x 540 mm



30095

**30095**  
**Crystal mirror**  
with all round facet cut  
Dimensions (w x h):  
525 x 960 mm  
650 x 650 mm  
950 x 650 mm  
1250 x 650 mm

The extraordinary surface characteristics and extremely fine colour nuances of our products can only be reproduced to a certain degree in print. Only the original KEUCO products, which can be viewed in sanitary trade dealers' showrooms, can provide you with an optimum impression.

Reproduction and copying, even if only excerpts, are only permitted by explicit permission of the manufacturer, and with the inclusion of source information.  
KEUCO GmbH & Co. KG, Postfach 1365, D-58653 Hemer

We reserve the right to make engineering changes for the purpose of improvement, as well as colour and design changes that are deemed necessary. Errors and omissions excepted.

Our articles are sold exclusively through sanitary wholesale.

Concept, design, text and lithography: KONTRAST Communication Services GmbH, Düsseldorf  
Photography: Thomas Krüsselmann, Viersen; Stephan Schacher, New York; Eva Gáida, Aalen;  
Casa, Münster; PF-Medien, Menden  
Printing: Meinders & Elstermann GmbH & Co. KG, Belm, Osnabrück  
Printed on GALAXI Keramik. Supplied by Papier Union.

For more information please visit [www.keuco.de](http://www.keuco.de)